

DAFTAR PUSTAKA

- American Bureau of Shipping (ABS). (2017). Rules for Building and Classing Marine Vessels. *ABS Publications*.
- Baso, Suandar. (2010). "An Eulerian Scheme with Lagrangian Particles for Computing Fluid Structure Interaction with Nonlinear Free Surface Flow In Marine Engineering. School of Engineering. Japan.
- Baso, S., Himaya, A.N., Samman, F.A., Anggraini, A.D.E., & Rosmani. (2021) "Experimental Investigation of Bow Slamming on a Ship : The Effect of Weight and Impact Angle". [Online].
Tersedia: <https://ejournal.undip.ac.id/index.php/kapal/article/view/35663/0> [Maret 2023]
- Baso, S., Mutsuda, H., & Doi, Y. (2014). "A Hybrid Particle-Grid Scheme for Computing Hydroelastic Behaviors Caused by Slamming". *Journal of Shipping and Ocean Engineering* . Japan.
- Bhattacharya, 1978. *Dynamic of Marine Vehicles*. New York, United State of America.
- Blakely, R. J., 1995, "Potential Theory in Gravity and Magnetic Applications", Cambridge University Press, USA
- Dallinga, R.P. "Bow Flare Slamming of Container Ship and It's Impact On Operational Reability". [Online].
Tersedia: https://www.researchgate.net/publication/51235477_Slamming_of_ships_Where_are_we_now [Maret 2023]
- Faltinsen, O. M. (1990). *Sea Loads on Ships and Offshore Structures*. Cambridge University Press.
- Ilmu Kapal dan Logistik. (2023). <https://www.kapaldanlogistik.com/2023/09/fungsi-dan-tipe-tipe-bulbous-bow-bagian-haluan-kapal.html> [Maret 2024].
- International Maritime Organization (IMO). (2014). Guidelines for Life-Saving Appliances. *IMO Publications*.
- Hagiwara, K & Yuhara, T. (1974). " Fundamental study of wave impact loads on ship Bows (1st Report)". Society of Naval Architects of Japan. Japan
- Kim, J., Park, S., & Lee, H. (2016). Structural Analysis of Life-Saving Boats Using Finite Element Method. *Marine Structures*, 49, 60-72.
- Kukuh Andreas (2019), "Analisis Numerik Pengaruh Inverted Bow Terhadap Badan Kapal Planning Hull Dan Rounded Hull Tipe High Speed Craft"

- Lloyd's Register. (2019). Case Study on Life-Saving Boats for Offshore Oil Rigs. *Lloyd's Register Technical Papers*.
- M.M.A. Mubarak, S. (2021). Investigasi Gerak Slamming pada Haluan Menggunakan Ansys. Slripsi Sarjana, Universitas Hasanuddin.
- Rousset J.M., Pettinotti B., Quillard O., Toularastel J.L. "Slamming Experiments On A Ship Model". [Online].
Tersedia: http://euerwme.iwwwfb.org/Abstracts/iwwwfb20/iwwwfb20_53.pdf .
[Juni 2024]
- Telford, W.M. et al, 1982. "Applied Geophysics". Cambridge University Press
Cambridge
- Tipler, P. A. (1998). "Physics for Scientists and Engineers. 4th ed." New York: W.H. Freeman and Company.
- Ulstein. (2024). <https://ulstein.com/vessels?type=anchor-handling-tug-supply-vessel>
[Maret 2024].
- Zhang, X., Li, Y., & Zhou, F. (2015). Methods of Dropping Test for Life-Saving Boats. *Journal of Marine Engineering and Technology*, 24(3), 45-57

LAMPIRAN

Lampiran 1 Nilai tekanan global dan impact pressure pada sudut kemiringan 5 derajat

No	Waktu (s)	Pa (kN/m ²)
1	0.00	0.00E+00
2	0.11	2.85E+07
3	0.22	3.46E+06
4	0.33	9.80E+06
5	0.44	1.07E+07
6	0.55	1.28E+07
7	0.66	5.04E+06
8	0.77	4.15E+06
9	0.88	4.94E+06
10	0.99	2.55E+06
11	1.10	3.45E+06
12	1.21	1.73E+06
13	1.32	2.12E+06
14	1.43	1.35E+06
15	1.54	1.49E+06
16	1.65	1.51E+06
17	1.76	1.26E+06
18	1.87	1.14E+06
19	1.98	1.27E+06
20	2.09	1.04E+06
21	2.20	9.13E+05

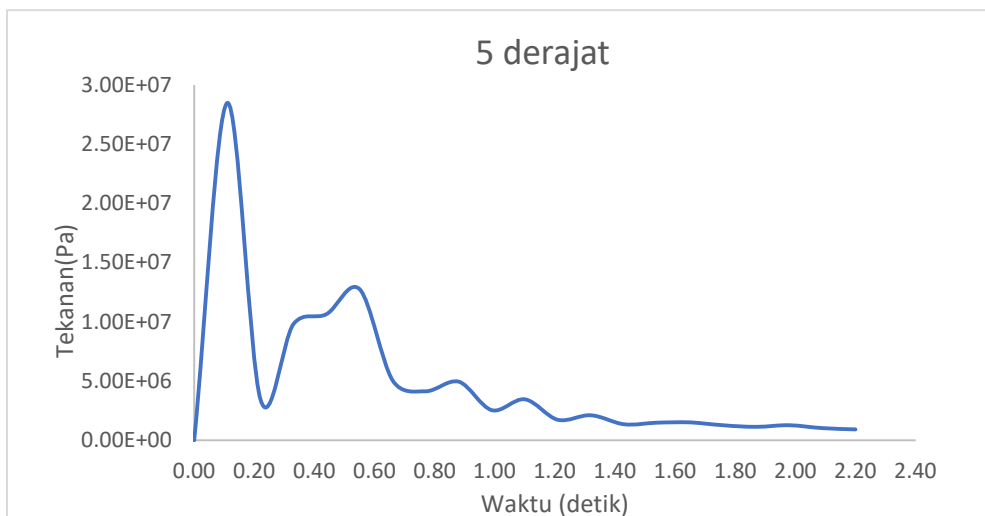

Waktu (detik)	Kemiringan haluan 5 derajat		
	poin 1	poin 2	poin 3
0,00	0,00E+00	0,00E+00	0,00E+00
0,11	2,34E+06	2,43E+06	3,41E+06
0,22	1,33E+06	8,96E+05	1,71E+06
0,33	2,50E+06	1,05E+06	2,63E+06
0,44	4,44E+06	3,47E+06	4,79E+06
0,55	5,31E+06	5,22E+06	3,80E+06
0,66	1,66E+06	1,66E+06	2,09E+06
0,77	1,30E+06	1,19E+06	1,60E+06
0,88	9,52E+05	8,84E+05	8,95E+05
0,99	7,48E+05	9,39E+05	9,21E+05
1,10	4,07E+05	7,92E+05	1,60E+05
1,21	6,57E+05	5,81E+05	7,75E+05
1,32	1,91E+05	4,61E+05	8,32E+05
1,43	3,94E+05	4,85E+05	6,92E+05
1,54	4,94E+05	5,51E+05	6,42E+05
1,65	1,23E+05	2,63E+05	6,12E+05
1,76	1,36E+05	2,38E+05	5,21E+05
1,87	3,51E+05	3,85E+05	6,65E+05
1,98	2,29E+05	2,89E+05	5,22E+05
2,09	4,07E+05	4,02E+05	6,58E+05
2,20	1,23E+05	1,72E+05	3,68E+05

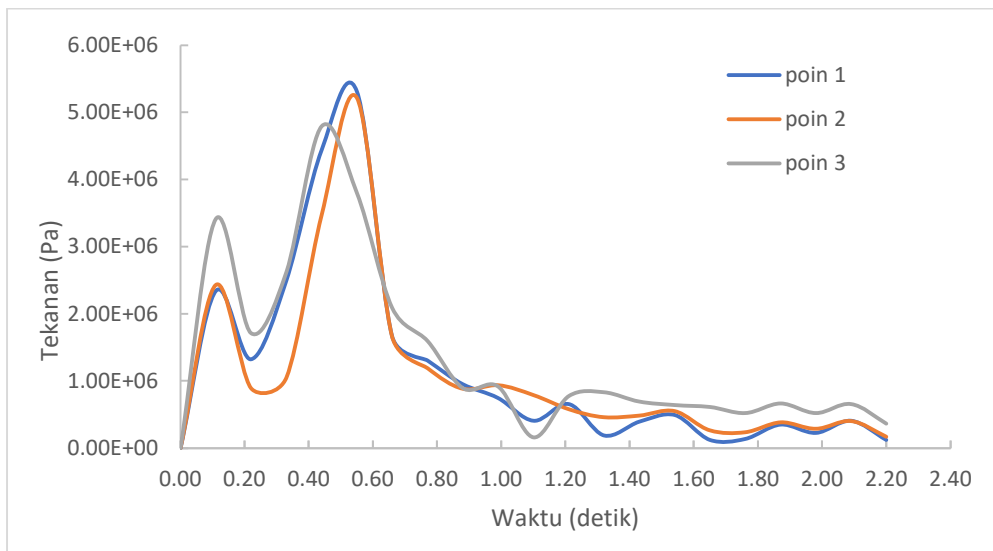

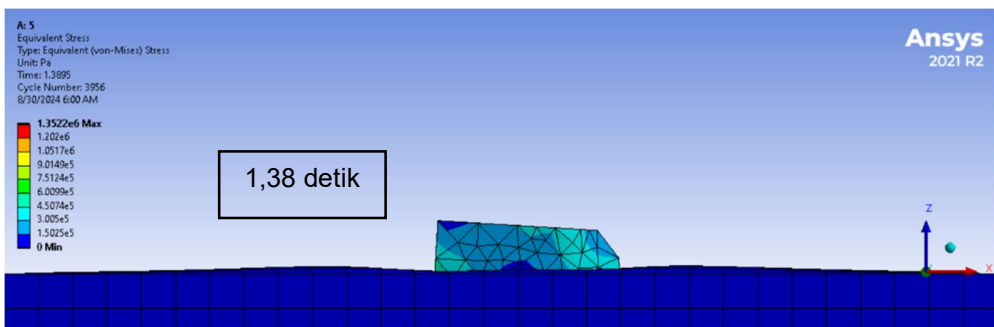
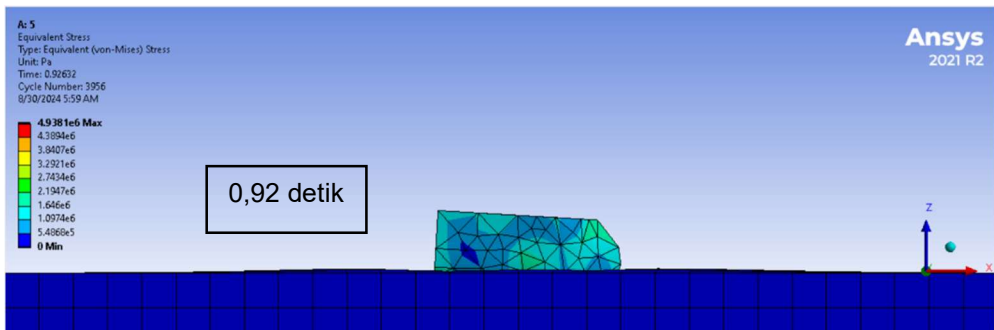
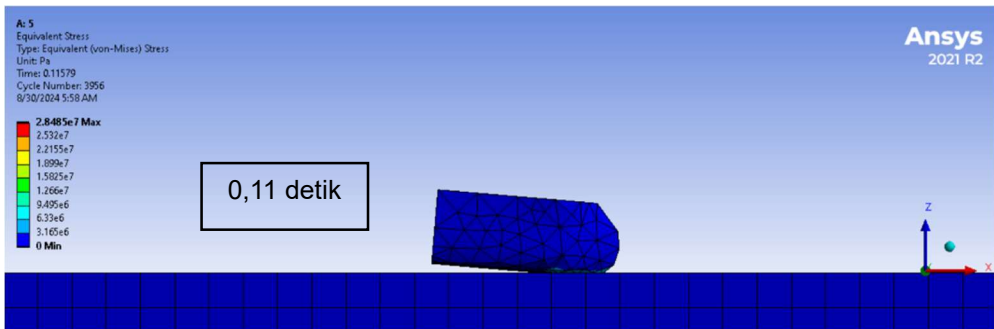
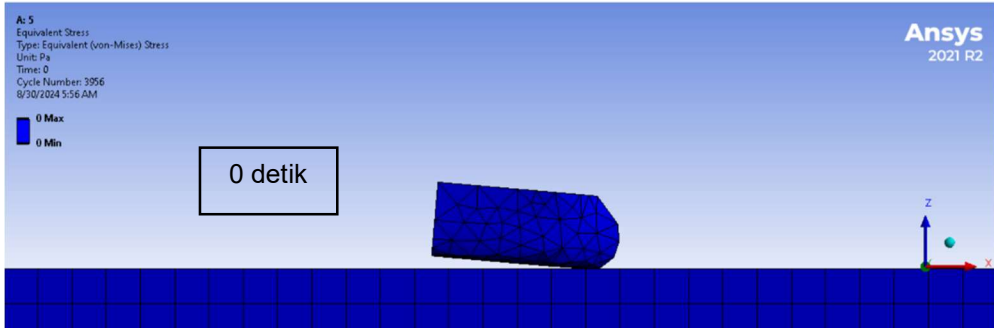

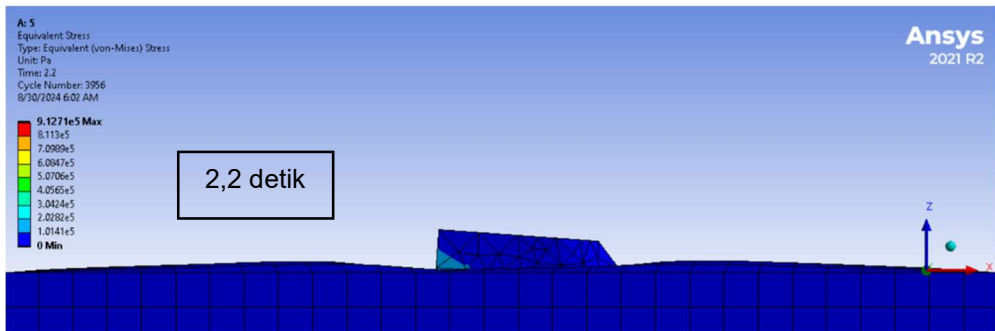
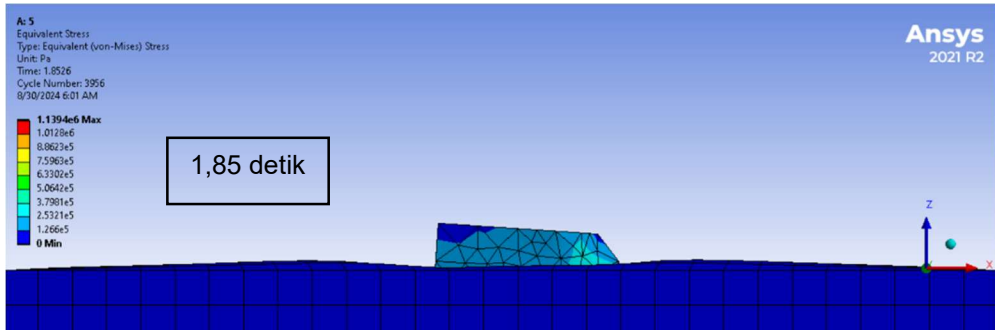

Lampiran 2 Nilai tekanan global dan impact pressure pada sudut kemiringan 10 derajat

No	Waktu (s)	Pa (kN/m ²)
1	0.00	0.00E+00
2	0.11	2.50E+07
3	0.22	1.23E+07
4	0.33	1.69E+07
5	0.44	7.34E+06
6	0.55	5.90E+06
7	0.66	1.23E+07
8	0.77	1.33E+07
9	0.88	1.09E+07
10	0.99	6.38E+06
11	1.10	3.93E+06
12	1.21	3.53E+06
13	1.32	2.18E+06
14	1.43	1.36E+06
15	1.54	1.26E+06
16	1.65	2.09E+06
17	1.76	1.15E+06
18	1.87	1.30E+06
19	1.98	1.07E+06
20	2.09	1.03E+06
21	2.20	1.03E+06

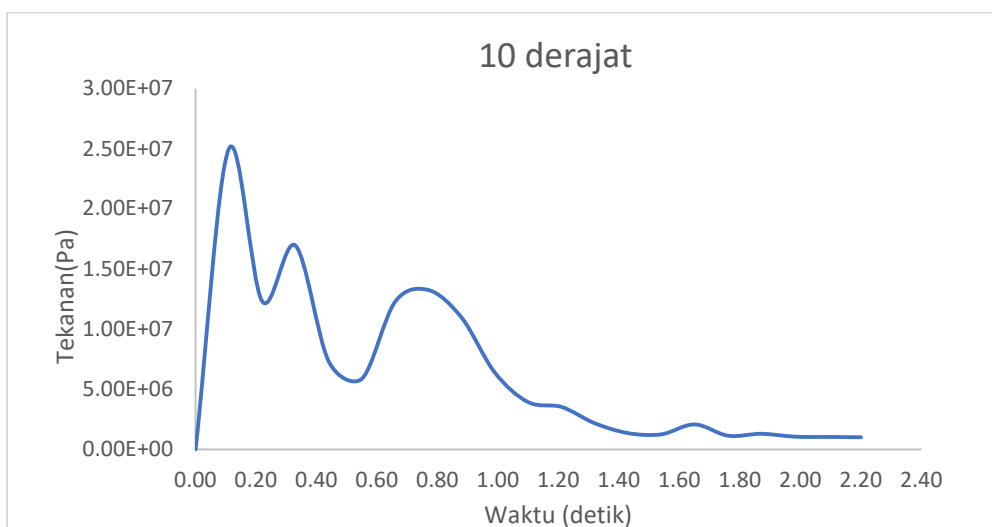

Waktu (detik)	Kemiringan haluan 10 derajat		
	poin 1	poin 2	poin 3
0,00	0,00E+00	0,00E+00	0,00E+00
0,11	1,40E+06	1,24E+06	1,32E+06
0,22	1,05E+06	4,63E+05	9,92E+05
0,33	2,11E+06	1,76E+06	1,94E+06
0,44	3,52E+06	2,60E+06	3,88E+06
0,55	1,62E+06	1,46E+06	1,42E+06
0,66	4,44E+06	4,29E+06	4,91E+06
0,77	3,76E+06	2,63E+06	3,46E+06
0,88	3,15E+06	2,33E+06	2,38E+06
0,99	3,41E+06	1,61E+06	1,67E+06
1,10	1,94E+06	6,80E+05	1,49E+06
1,21	5,09E+05	7,02E+05	7,73E+05
1,32	8,77E+05	1,02E+06	7,27E+05
1,43	4,37E+05	4,72E+05	7,34E+05
1,54	1,90E+05	3,43E+05	5,86E+05
1,65	3,12E+05	2,87E+05	4,03E+05
1,76	7,36E+05	5,88E+05	4,79E+05
1,87	1,93E+05	3,70E+05	5,34E+05
1,98	2,78E+05	3,51E+05	6,15E+05
2,09	1,68E+05	2,12E+05	2,83E+05
2,20	1,90E+05	2,64E+05	4,45E+05

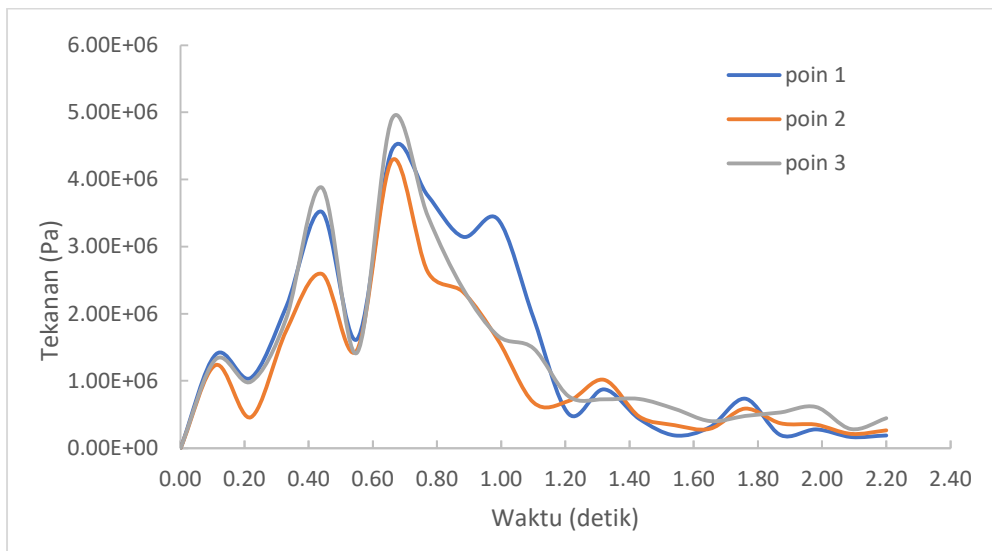

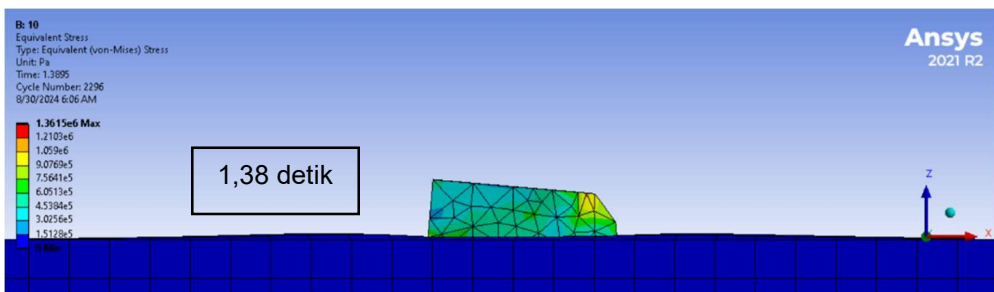
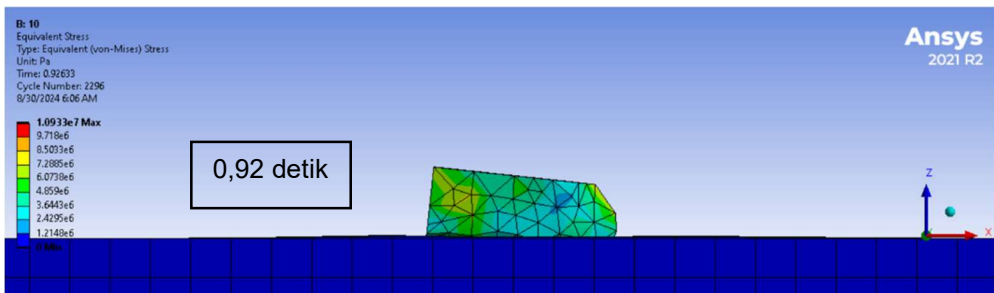
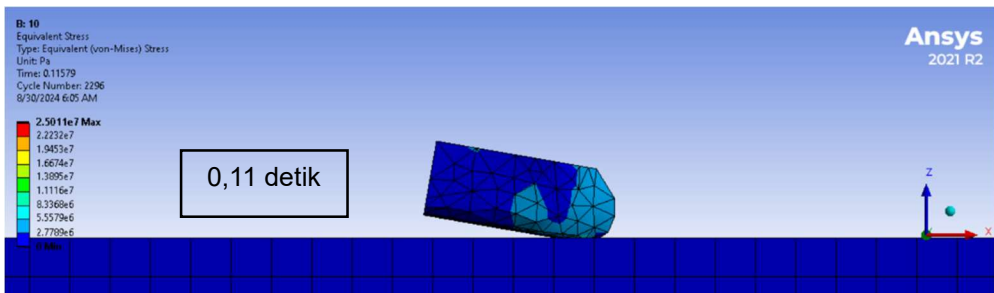
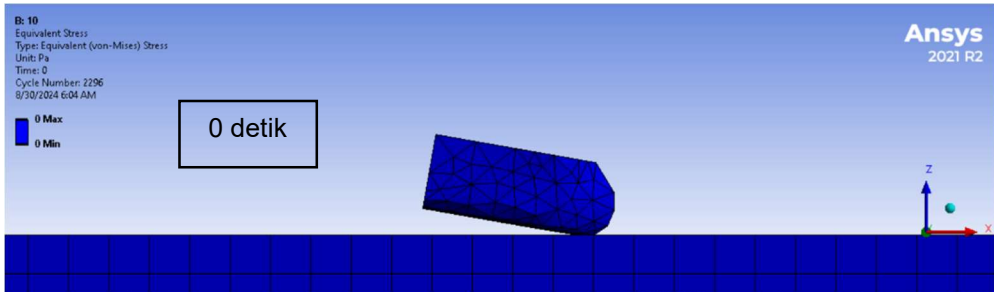

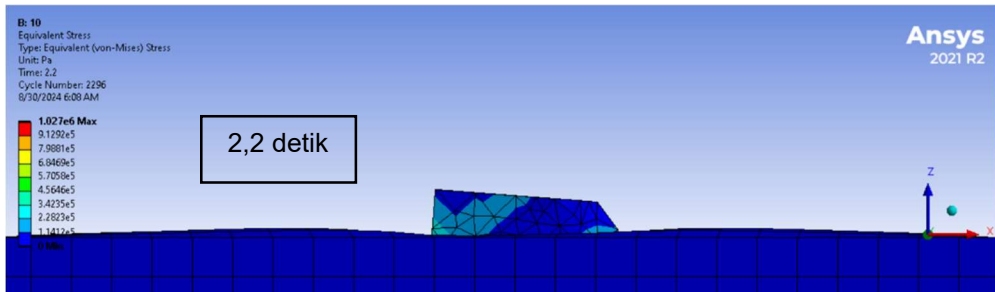
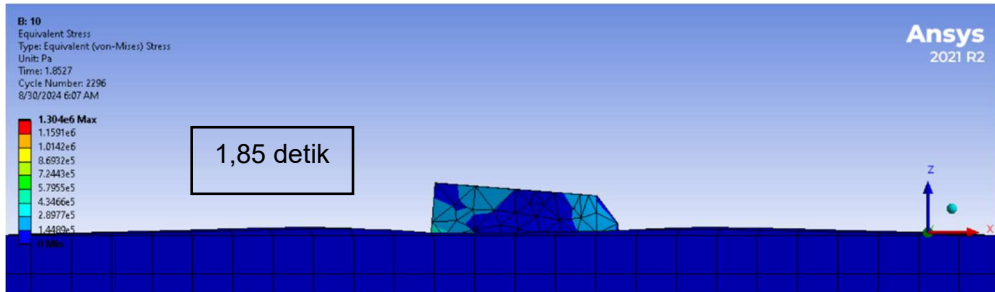

Lampiran 3 Nilai tekanan global dan impact pressure pada sudut kemiringan 15 derajat

No	Waktu (s)	Pa (kN/m ²)
1	0.00	0.00E+00
2	0.11	2.44E+07
3	0.22	1.19E+07
4	0.33	5.59E+06
5	0.44	6.07E+06
6	0.55	7.14E+06
7	0.66	3.35E+06
8	0.77	5.77E+06
9	0.88	5.13E+06
10	0.99	1.63E+07
11	1.10	5.13E+06
12	1.21	8.85E+06
13	1.32	9.34E+06
14	1.43	1.27E+07
15	1.54	5.39E+06
16	1.65	4.80E+06
17	1.76	3.95E+06
18	1.87	2.89E+06
19	1.98	3.12E+06
20	2.09	2.66E+06
21	2.20	2.85E+06

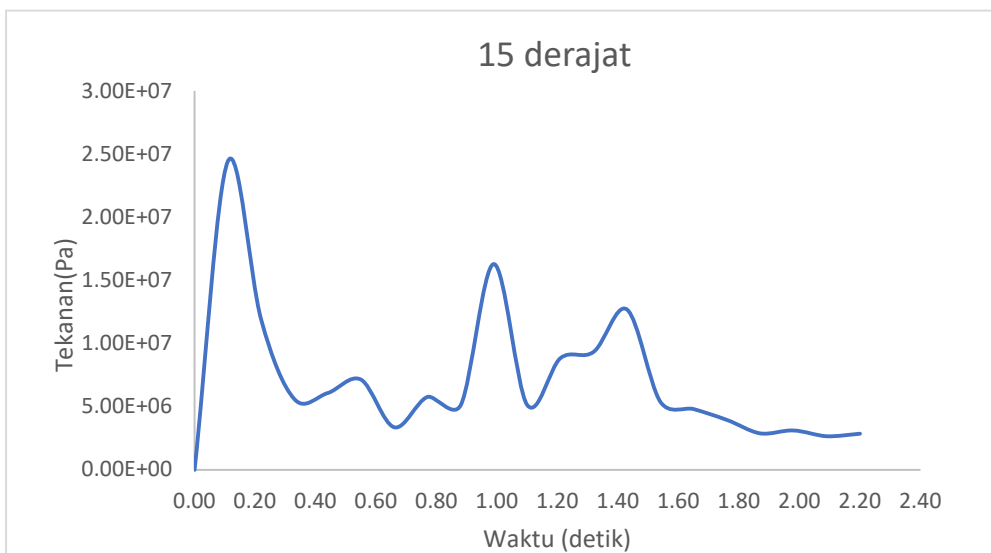

Waktu (detik)	Kemiringan haluan 15 derajat		
	poin 1	poin 2	poin 3
0,00	0,00E+00	0,00E+00	0,00E+00
0,11	3,52E+06	3,37E+06	7,55E+06
0,22	8,26E+05	1,25E+06	4,38E+06
0,33	1,19E+06	8,90E+05	1,50E+06
0,44	2,37E+06	2,60E+06	2,58E+06
0,55	1,53E+06	2,08E+06	3,50E+06
0,66	4,05E+05	3,23E+05	1,38E+06
0,77	1,49E+06	1,65E+06	1,04E+06
0,88	1,64E+06	2,11E+06	2,07E+06
0,99	2,74E+06	3,06E+06	3,12E+06
1,10	1,13E+06	1,19E+06	1,11E+06
1,21	2,76E+06	3,12E+06	2,58E+06
1,32	1,81E+06	1,71E+06	1,57E+06
1,43	1,57E+06	1,29E+06	1,01E+06
1,54	1,66E+06	1,85E+06	1,26E+06
1,65	1,03E+05	1,26E+06	7,85E+05
1,76	1,17E+06	1,42E+06	1,24E+06
1,87	3,85E+05	4,86E+05	5,09E+05
1,98	2,37E+05	8,62E+05	6,82E+05
2,09	6,43E+05	8,28E+05	8,38E+05
2,20	8,03E+05	8,58E+05	1,09E+04

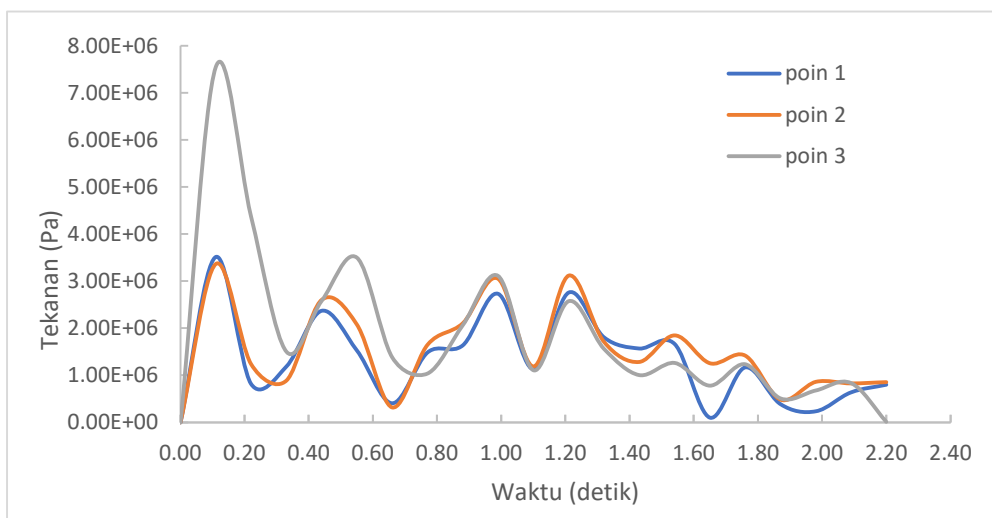

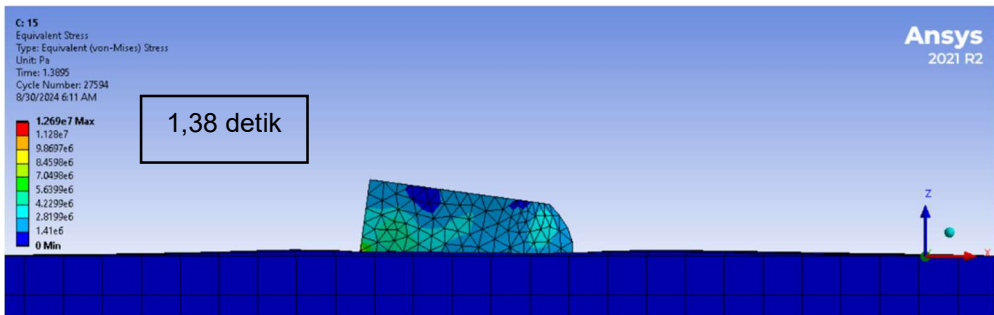
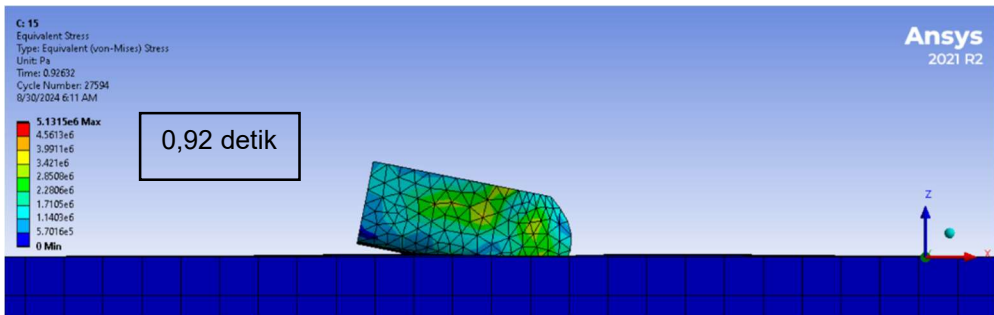
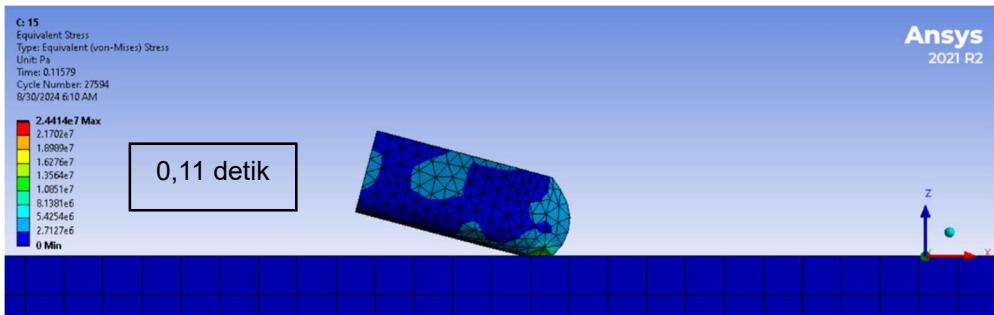
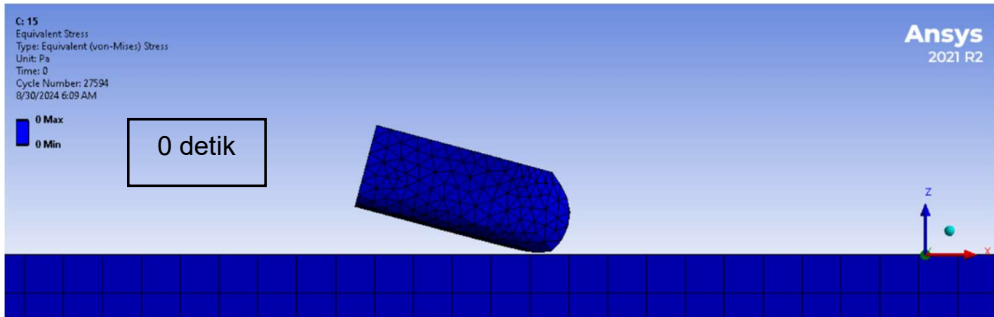

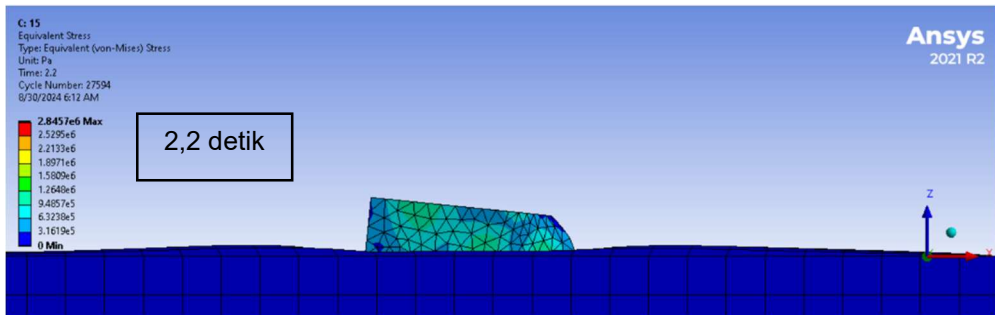
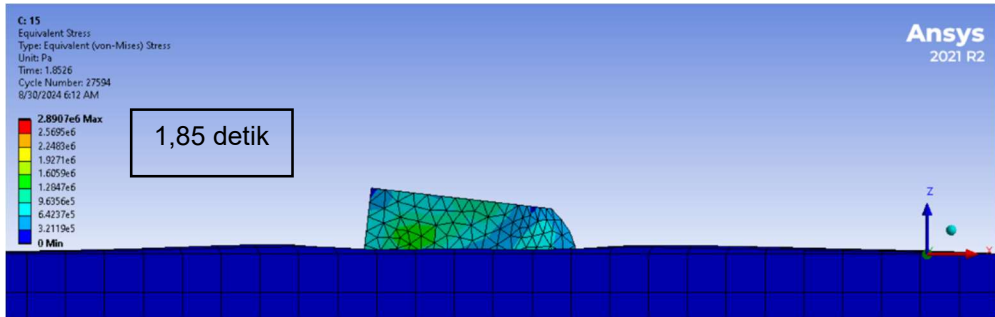

Lampiran 4 Nilai tekanan global dan impact pressure pada sudut kemiringan 20 derajat

No	Waktu (s)	Pa (kN/m ²)
1	0.00	0.00E+00
2	0.11	2.02E+07
3	0.22	5.85E+06
4	0.33	9.02E+06
5	0.44	6.62E+06
6	0.55	5.18E+06
7	0.66	7.19E+06
8	0.77	5.34E+06
9	0.88	5.80E+06
10	0.99	3.38E+06
11	1.10	3.57E+06
12	1.21	6.66E+06
13	1.32	6.66E+06
14	1.43	4.20E+06
15	1.54	7.17E+06
16	1.65	7.87E+06
17	1.76	5.56E+06
18	1.87	5.86E+06
19	1.98	2.63E+06
20	2.09	3.17E+06
21	2.20	2.49E+06

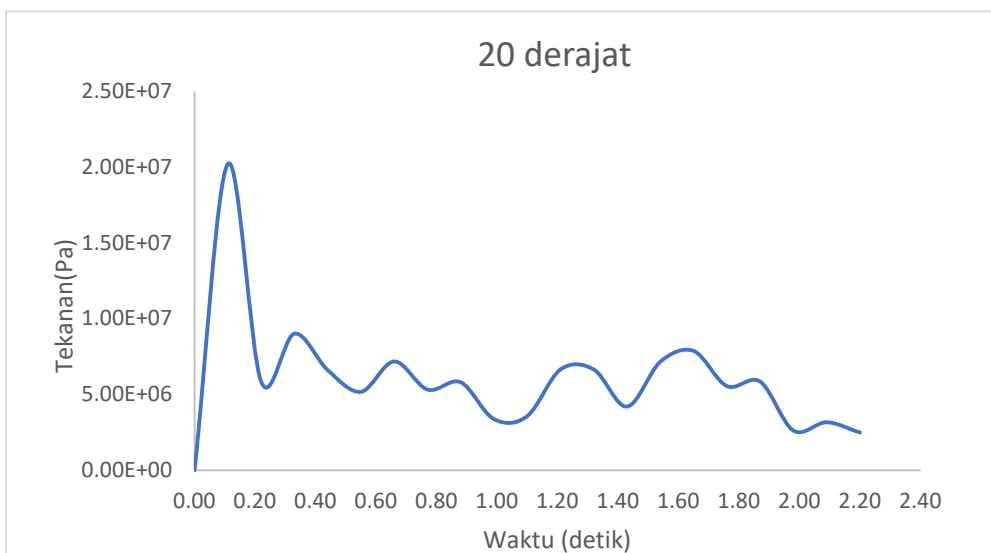

Waktu (detik)	Kemiringan haluan 20 derajat		
	poin 1	poin 2	poin 3
0,00	0,00E+00	0,00E+00	0,00E+00
0,11	3,20E+06	4,96E+06	1,08E+07
0,22	2,08E+06	2,94E+06	6,64E+06
0,33	2,06E+06	3,30E+06	7,30E+06
0,44	1,57E+06	2,00E+06	4,12e+006
0,55	1,02E+06	1,78E+06	4,30E+06
0,66	3,90E+05	9,33E+05	2,77E+06
0,77	1,21E+06	5,67E+05	4,22E+05
0,88	1,41E+06	1,52E+06	1,59E+06
0,99	1,64e+006	1,86E+06	2,16E+06
1,10	3,22E+06	2,93E+06	2,64E+06
1,21	1,44E+06	7,76E+05	1,21E+06
1,32	1,20E+06	7,93E+05	7,61E+06
1,43	1,49E+06	1,34E+06	2,17E+06
1,54	1,76E+06	2,27E+06	3,91E+06
1,65	1,06E+06	1,16E+06	1,17E+06
1,76	1,71E+06	1,95E+06	2,92E+06
1,87	8,53E+05	6,71E+05	6,87E+05
1,98	8,58E+05	1,28E+06	1,76E+06
2,09	7,17E+05	7,13E+05	1,10E+06
2,20	6,43e+005	4,85E+05	8,87E+05

