

DAFTAR PUSTAKA

- Asroni, A. (2010). *Balok dan Pelat Beton Bertulang*. Graha Ilmu.
- Badan Standardisasi Nasional. (2020). *Beban Desain Minimum dan Kriteria Terkait Untuk Bangunan Gedung dan Struktur Lain (SNI 1727:2020)*. BSN
- Badan Standardisasi Nasional. (2019). *Tata Cara Perencanaan Ketahanan Gempa untuk Struktur Bangunan Gedung dan Non Gedung (SNI 1726:2019)*. BSN.
- Badan Standardisasi Nasional. (2019). *Persyaratan Beton Struktural Untuk Bangunan Gedung (SNI 2847:2019)*. BSN.
- Badan Standardisasi Nasional. (2017). *Baja Tulangan Beton (SNI 2052:2017)*. BSN.
- CSI, Computers and Structures, Inc. (2016). *CSI Analysis Reference Manual For SAP2000, ETABS, SAFE and CSiBridge*.
<https://docs.csiamerica.com/manuals/sap2000/CSiRefer.pdf>
- Kementrian PUPR. (2023, Maret 8). *Aplikasi Respon Spektra 2021*.
<https://rsa.ciptakarya.pu.go.id/2021/>
- PT Silar Rancang Bangun. (2017). *Soil Investigation Report, Pekerjaan Penyelidikan Tanah Untuk Proyek Pembangunan Rumah Sakit Ika Makassar Provinsi Sulawesi Selatan*.
- Setiawan, A. (2016). *Perancangan Struktur Beton Bertulang Berdasarkan SNI 2847 : 2013*. Erlangga.
- Structure Point. (2021). *SPColumn Manual*.
<https://structurepoint.org/pdfs/manuals/spColumn-Manual.pdf>
- Suharjanto. (2013). *Rekayasa Gempa*. Universitas Janabardra.

LAMPIRAN

Lampiran 1 Gambar Diagram Momen *Frame*

1. Diagram momen akibat beban mati

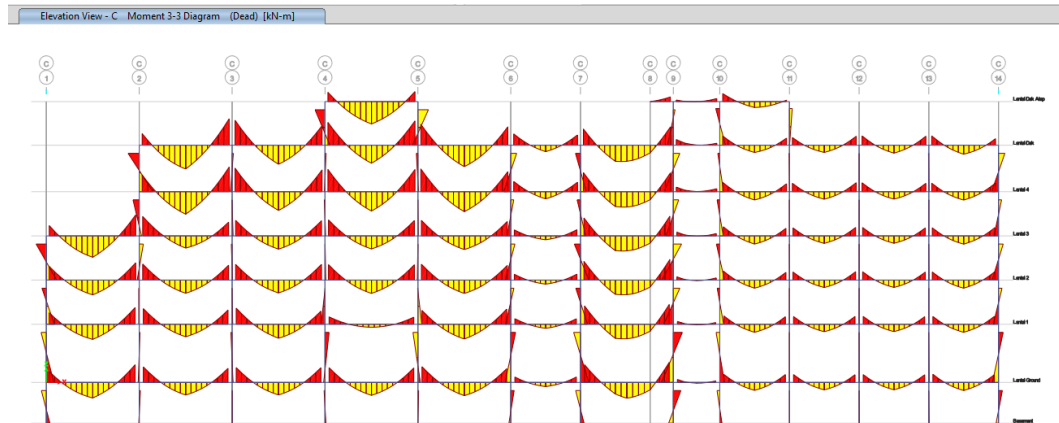

2. Diagram momen terhadap beban mati tambahan

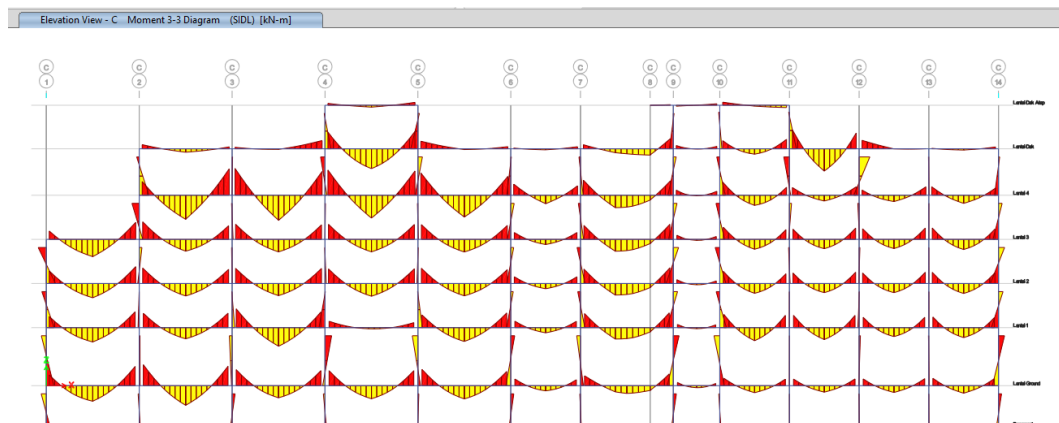

3. Diagram momen terhadap beban hidup

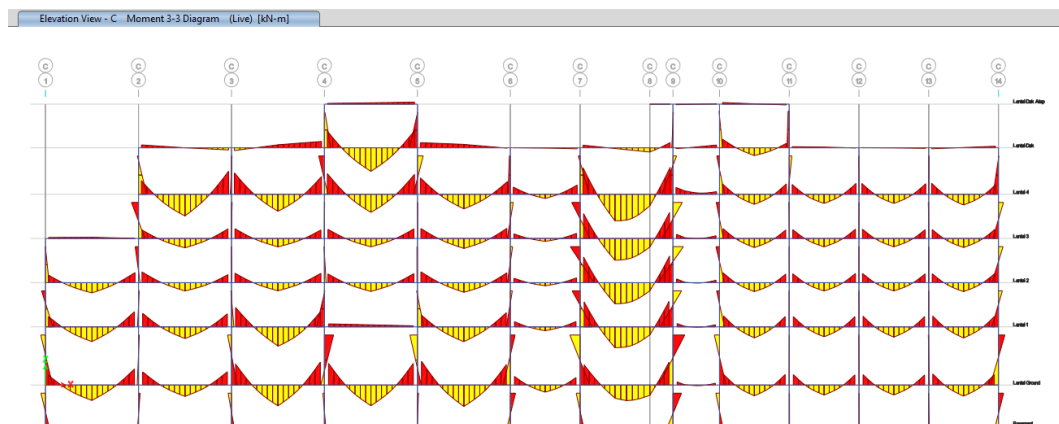

4. Diagram momen terhadap beban gempa

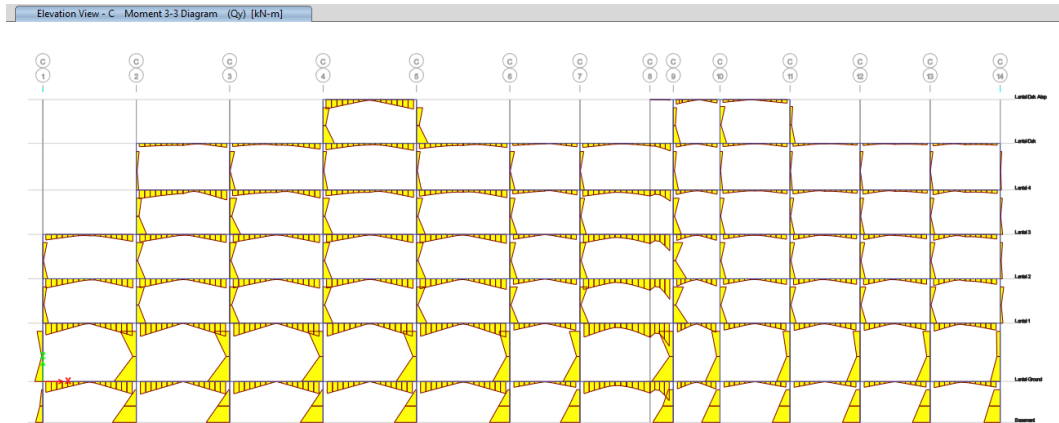

5. Diagram momen kombinasi beban mati dan beban hidup

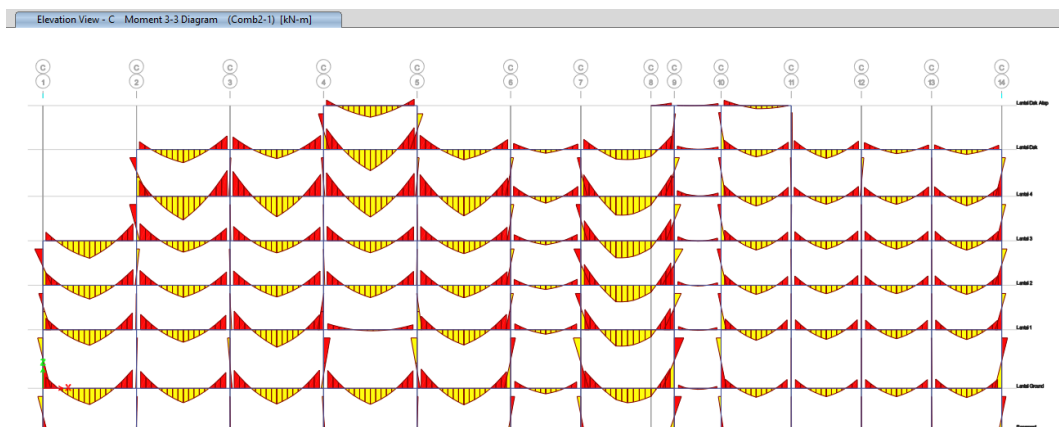

6. Diagram momen pada balok anak

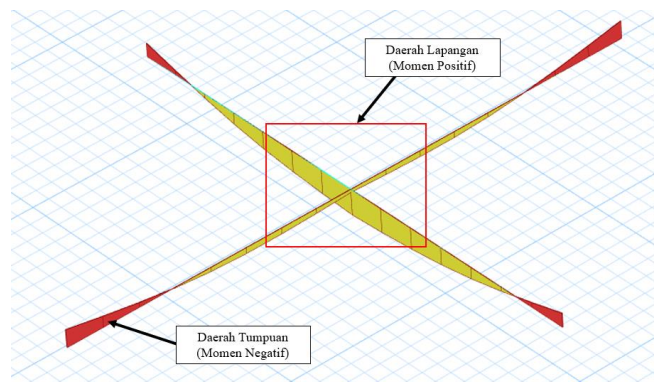
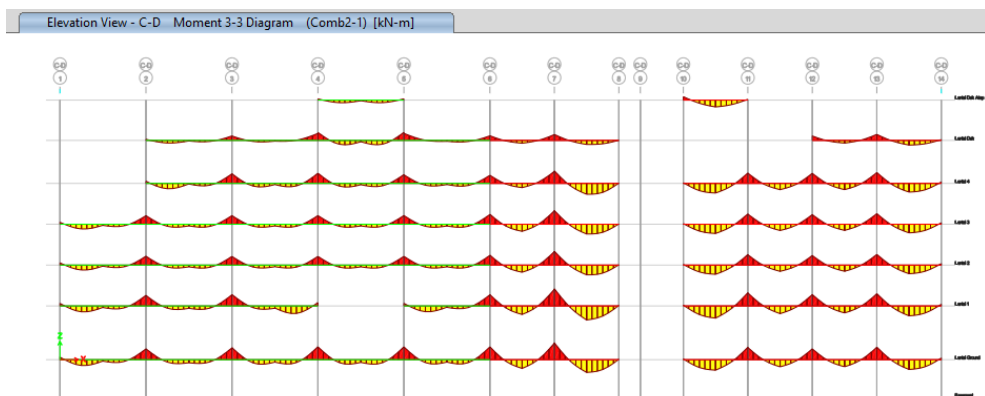

Lampiran 2 Gambar Momen Pada Pelat

1. Momen pelat terhadap kombinasi beban mati dan beban hidup arah X

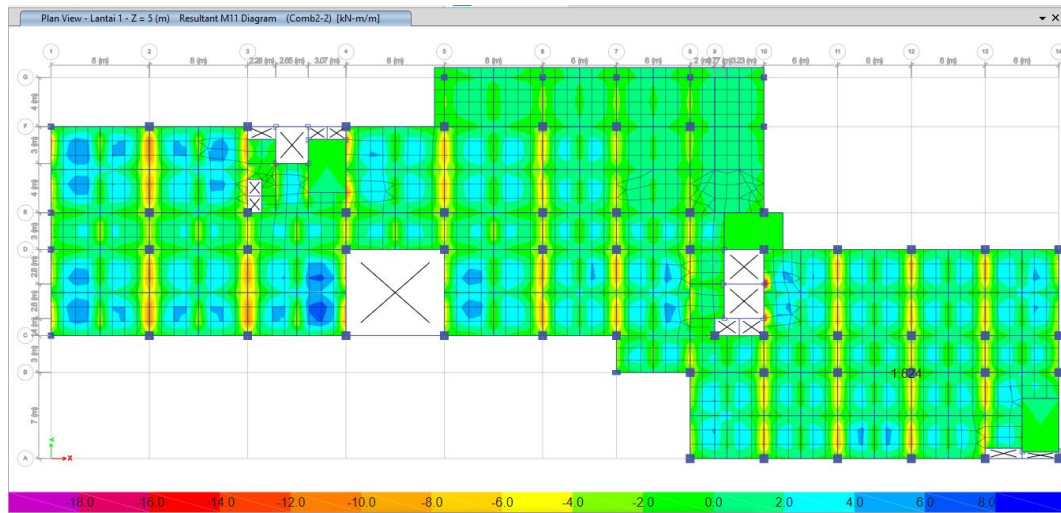

2. Momen pelat terhadap kombinasi beban mati dan beban hidup arah Y

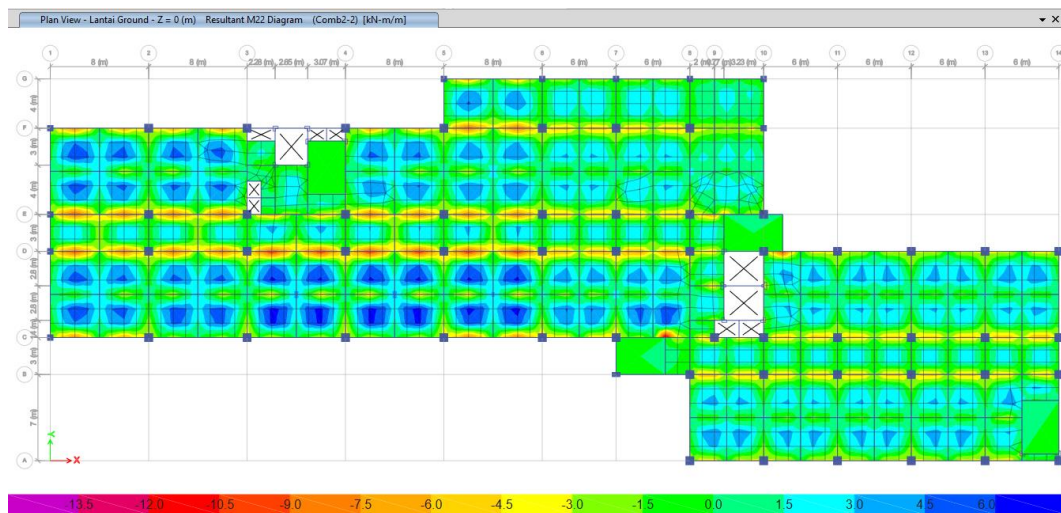

Lampiran 3 Gambar Diagram Interaksi Kolom

1. Diagram interaksi kolom K1.a

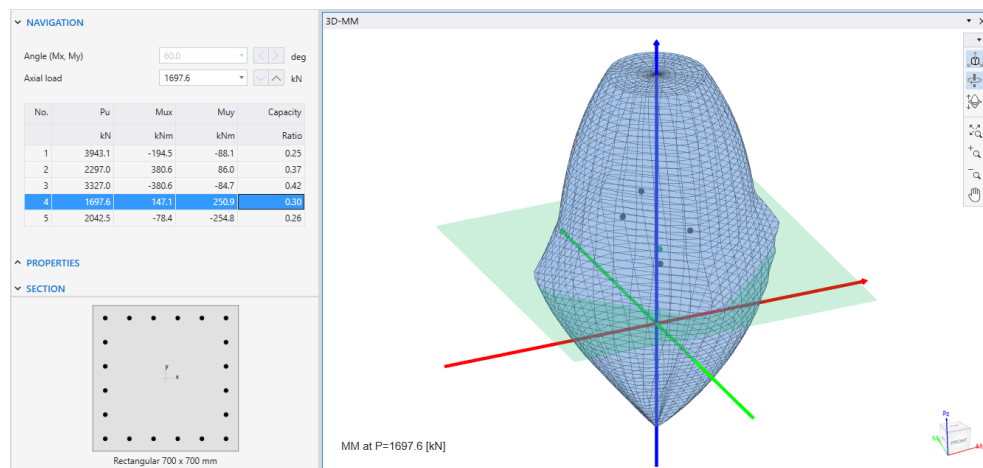

2. Diagram interaksi kolom K1.b

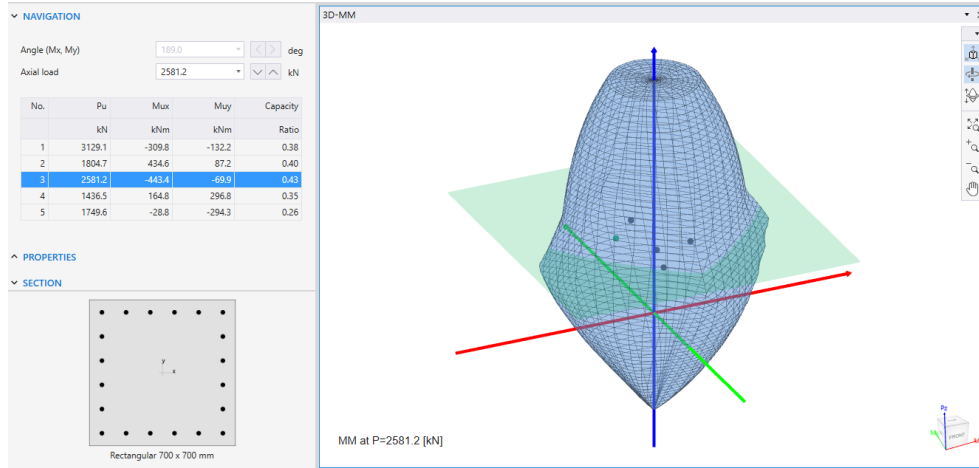

3. Diagram interaksi kolom K2

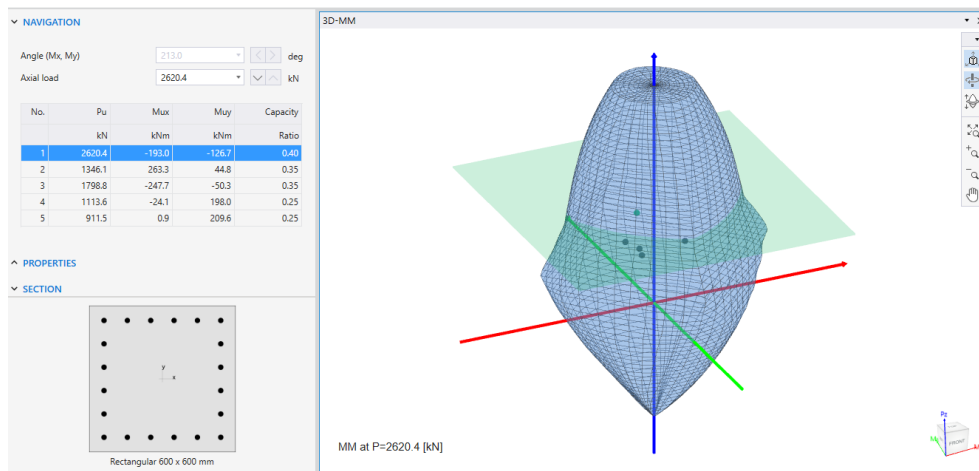

4. Diagram interaksi kolom K3.a

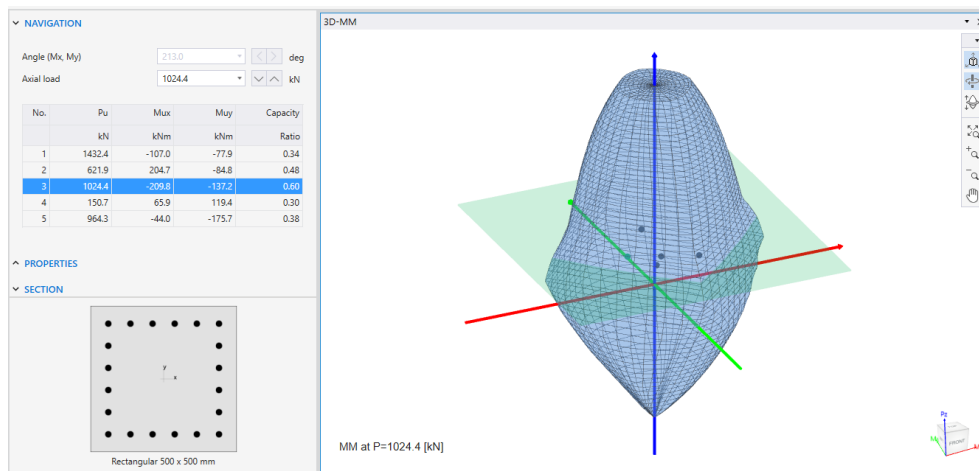

5. Diagram interaksi kolom K3.b

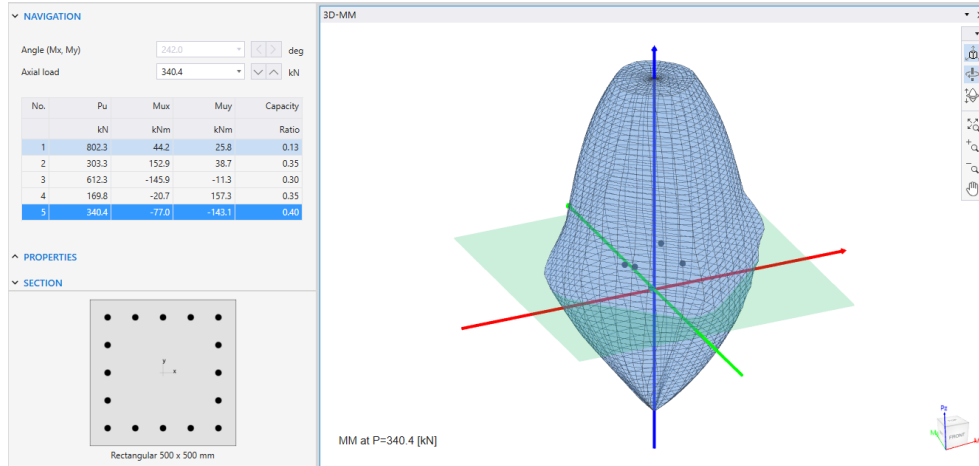

6. Diagram interaksi kolom K3.c

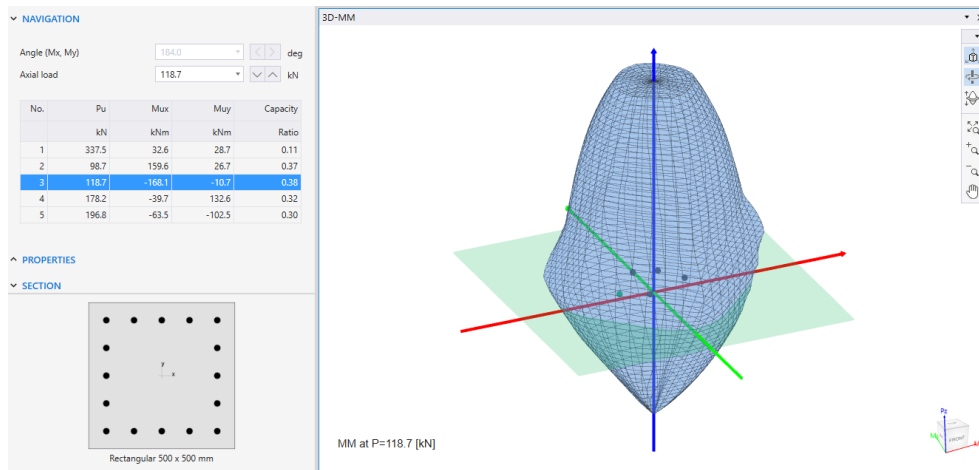

7. Diagram interaksi kolom K5

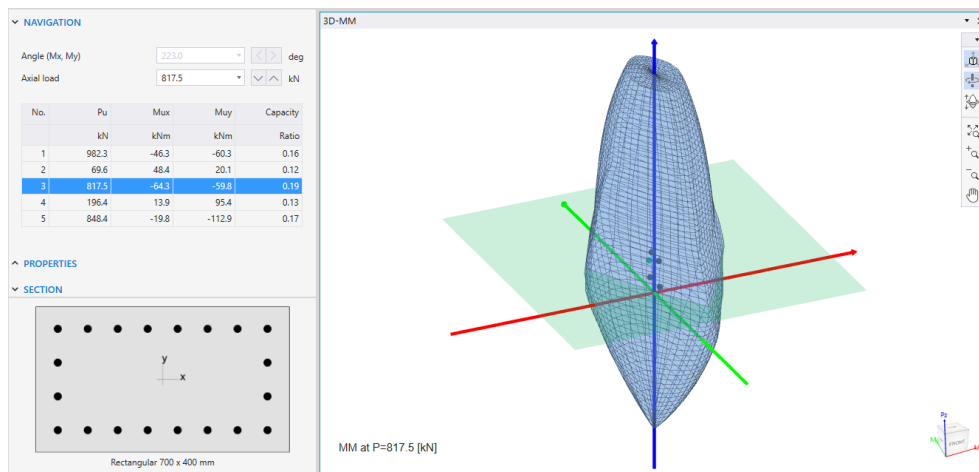

8. Diagram interaksi kolom K6

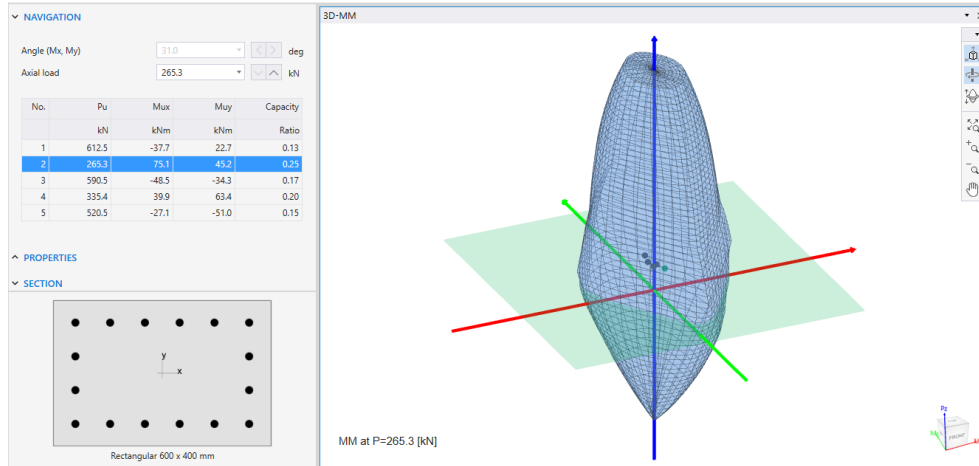

9. Diagram interaksi kolom K7

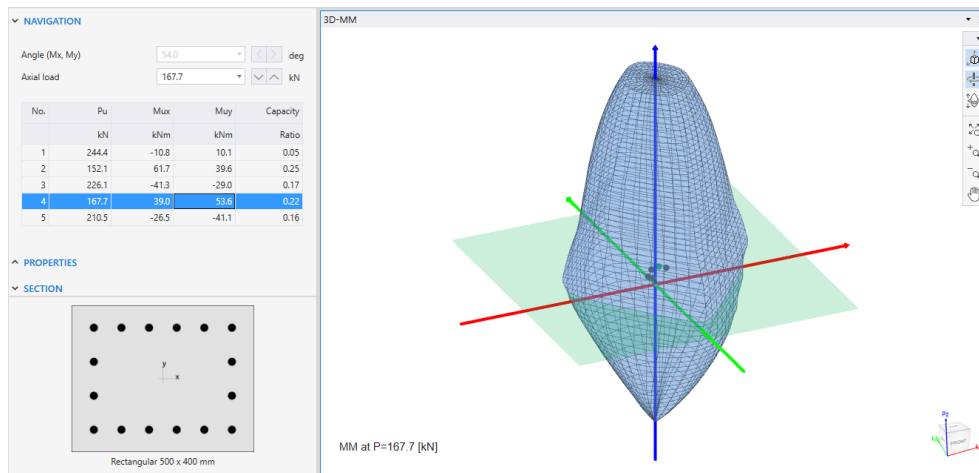

Lampiran 4 Kontur tegangan beton bertulang pada balok G1-a dengan *software* LUSAS Modeler

