

DAFTAR PUSTAKA

1. Arismunandar, W., H. Saito. 2002. *Penyegar Udara*. Edisi keenam, PT. Pradnya Paramita, Jakarta
2. Arora, C.P. *Refrigeration and Air Conditioning*. Tata McGraw-Hill Publising Company Limited, New Delhi
3. Bolaji, B.O. 2010. Experimental Study of R152a and R32 to Replace R134a in a Domestic Refrigerator. *Journal Energy* 35, 3793-3798, Nigeria
4. Bolaji, B.O. 2012. Performance of a R22 split air conditioner when retrofitted with ozone friendly refrigerants (R410A and R417A). *Journal Energy in south Africa* vol 23 no 3, Nigeria
5. Carrier Air Conditioning Company, 1965, *Handbook of Air Conditioning System* McGraw-Hill Book Company, New York
6. Irwan. 2011. Analisis Pengaruh Laju Aliran Massa Udara Masuk Evaporator Terhadap Prestasi Mesin Pendingin Model. BC/EV. Tesis Pasca Sarjana Unhas, Makassar
7. M. Boumaza. 2010. Performances Assesment of Natural Refrigerants as Subtitutes to CFC and HCFC in Hot Climate. *International Journal of Thermal and Environmental Engineering* vol 1 no 2, Saudi Arabia
8. N. Murugan dkk. 2013. Development of Statistical Models for Predicting Performance of R22, R134a and R290/R600a Mixture Refrigerants using Design of Experiments. *International Journal of Thermodynamics (IJoT)* vol. 16 no.1, India

LAMPIRAN

Lampiran A



Gambar A.1 Refrigeran R22



Gambar A.2 Refrigeran R134a



Gambar A.3 Refrigeran Propan



Gambar A.4 Refrigeran Isobutan



Gambar A.5 Instalasi pengujian outdoor



Gambar A.7 Alat pengukur tekanan



Gambar A.8 Termokopel digital



Gambar A.9 Anemometer



Gambar A.10 Timbangan digital



Gambar A.11 Manifold



Gambar A.12 Amperemeter



Gambar A.13 Refrigeran gas analyzer

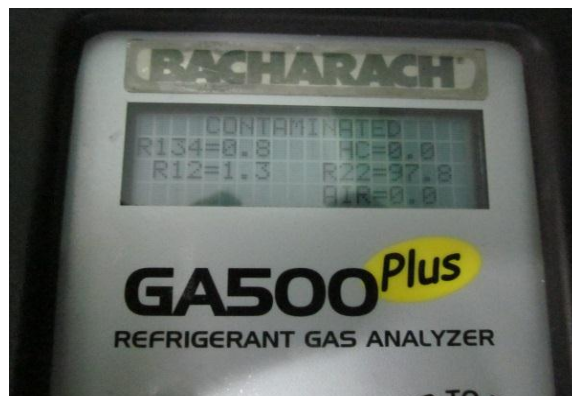

Gambar A.14 Hasil pengujian refrigeran R22



Gambar A.15 Pompa Vakum

Lampiran C

Tabel C.1.1 Data Evaporator R22

No	Waktu	P	T _{inlet}	T _{outlet}	V _{udara}	T _{inlet udara}	T _{outlet udara}	T _{ruangan}
	menit	kpa	(^o C)	(^o C)	m/s	(^o C)	(^o C)	(^o C)
1	5	496	13.4	24.1	3.9	27.1	20.8	26.9
2	10	496	13.0	23.2	4.1	26.2	19.2	26.0
3	15	503	12.6	22.5	4.0	25.8	18.2	25.8
4	20	503	12.6	22.0	4.1	25.3	17.2	24.9
5	25	503	12.3	21.6	4.1	25.2	16.8	24.6
6	30	503	12.1	21.2	4.0	24.8	16.5	24.4
7	35	503	12.0	21.0	4.1	24.6	16.2	24.1
8	40	503	11.9	20.9	4.0	24.4	15.8	24.0
9	45	496	11.8	20.8	4.0	24.1	15.4	23.9
10	50	496	11.7	20.6	4.1	24.1	15.4	23.8
11	55	496	11.7	20.5	4.0	23.8	15.2	23.7
12	60	496	11.7	20.4	4.0	23.9	15.1	23.7
13	65	496	11.6	20.3	4.0	23.8	14.9	23.6
14	70	496	11.6	20.2	4.1	23.8	14.9	23.5
15	75	496	11.5	20.2	4.0	23.7	14.8	23.5
16	80	496	11.5	20.2	4.1	23.6	14.8	23.4
17	85	490	11.5	20.2	4.0	23.5	14.7	23.4
18	90	490	11.4	20.1	4.0	23.4	14.6	23.1
19	95	490	11.4	20.1	4.0	23.4	14.4	22.9
20	100	490	11.4	20.1	4.0	23.2	14.3	22.8
21	105	490	11.3	20.0	4.0	23.1	14.3	22.8
22	110	490	11.3	20.0	4.0	23.1	14.2	22.7
23	115	483	11.3	20.1	4.0	23.0	14.1	22.7
24	120	483	11.3	20.1	4.0	22.9	14.0	22.5
25	125	483	11.3	20.1	4.0	22.9	13.9	22.3
26	130	483	11.4	20.1	4.0	22.9	13.9	22.3
27	135	483	11.4	20.1	4.1	23.0	13.9	22.2
28	140	483	11.4	20.1	4.1	22.9	13.8	22.2
29	145	483	11.3	20.0	4.0	22.9	13.9	22.1
30	150	483	11.2	20.0	4.0	23.0	13.8	21.9
31	155	483	11.2	19.9	4.1	22.9	13.8	21.8
32	160	483	11.3	19.8	3.9	22.8	13.8	21.7
33	165	483	11.3	19.9	4.0	22.9	14.2	21.6
34	170	483	11.2	19.8	4.0	22.8	14.4	21.5
35	175	483	11.1	19.7	4.0	22.9	14.4	21.4
36	180	483	11.1	19.7	4.0	22.8	14.3	21.4
37	185	483	10.9	19.7	4.0	22.8	14.4	21.4
38	190	483	11.0	19.8	4.0	22.9	14.3	21.4
39	195	483	11.1	19.8	4.0	22.8	14.3	21.4
40	200	483	11.1	19.8	4.1	22.8	14.4	21.4

Tabel C.1.2 Data Evaporator R134a

No	Waktu	P	T _{inlet}	T _{outlet}	V _{udara}	T _{inlet udara}	T _{outlet udara}	T _{ruangan}
	menit	kpa	(°C)	(°C)	m/s	(°C)	(°C)	(°C)
1	5	448.2	22.0	24.8	3.1	28.7	22.9	29.6
2	10	413.7	22.0	22.7	3.1	28.5	22.4	29.0
3	15	406.8	21.8	22.1	3.1	28.3	21.8	28.6
4	20	399.9	21.7	21.6	3.2	28.2	21.4	28.5
5	25	399.9	21.7	21.4	3.1	27.8	21.1	28.3
6	30	393.0	21.2	21.2	3.2	27.8	20.8	28.1
7	35	393.0	21.0	21.0	3.2	27.6	20.6	28.0
8	40	386.1	20.9	20.9	3.2	27.5	20.4	27.9
9	45	386.1	20.8	20.8	3.1	27.4	20.2	27.8
10	50	386.1	20.7	20.7	3.2	27.4	20.1	27.7
11	55	386.1	20.6	20.6	3.2	27.3	19.9	27.6
12	60	386.1	20.5	20.5	3.2	27.2	19.8	27.6
13	65	379.2	20.4	20.4	3.1	27.2	19.7	27.6
14	70	379.2	20.4	20.4	3.1	27.2	19.7	27.5
15	75	379.2	20.3	20.3	3.2	27.2	19.7	27.4
16	80	379.2	20.2	20.2	3.2	27.1	19.6	27.4
17	85	379.2	20.2	20.2	3.1	27.1	19.5	27.3
18	90	379.2	20.1	20.1	3.1	27.0	19.4	27.2
19	95	379.2	20.0	20.0	3.2	26.9	19.3	27.2
20	100	379.2	20.0	19.9	3.2	26.8	19.3	27.2
21	105	379.2	20.0	19.9	3.2	26.8	19.3	27.2
22	110	379.2	20.0	19.9	3.2	26.8	19.3	27.2
23	115	379.2	20.0	19.9	3.2	26.8	19.3	27.2
24	120	379.2	20.0	19.9	3.2	26.8	19.3	27.2
25	125	379.2	20.0	19.9	3.2	26.8	19.3	27.2
26	130	379.2	20.0	19.9	3.2	26.8	19.3	27.2
27	135	379.2	19.9	19.9	3.2	26.8	19.3	27.2
28	140	379.2	19.9	19.9	3.2	26.8	19.3	27.2
29	145	379.2	19.9	19.9	3.2	26.8	19.3	27.2
30	150	379.2	19.9	19.9	3.2	26.8	19.3	27.2
31	155	379.2	19.9	19.9	3.2	26.8	19.3	27.2
32	160	379.2	19.8	19.9	3.2	26.8	19.3	27.2
33	165	379.2	19.8	19.9	3.2	26.8	19.3	27.2
34	170	379.2	19.8	19.9	3.2	26.8	19.3	27.2
35	175	379.2	19.8	19.9	3.2	26.8	19.3	27.2
36	180	379.2	19.7	19.9	3.2	26.8	19.3	27.2
37	185	379.2	19.7	19.9	3.2	26.8	19.3	27.2
38	190	379.2	19.7	19.9	3.2	26.8	19.3	27.2
39	195	379.2	19.7	19.9	3.2	26.8	19.3	27.2
40	200	379.2	19.7	19.9	3.2	26.8	19.3	27.2

Tabel C.1.3 Data Evaporator Propan 100%

No	Waktu	P	T _{inlet}	T _{outlet}	V _{udara}	T _{inlet udara}	T _{outlet udara}	T _{ruangan}
	menit							
1	5	420.6	13.4	24.1	3.2	26.8	21.9	26.4
2	10	420.6	13.0	23.2	3.2	26.1	20.4	25.6
3	15	427.5	12.6	22.5	3.2	25.6	19.9	25.1
4	20	427.5	12.6	22.0	3.3	25.3	19.6	24.9
5	25	427.5	12.3	21.6	3.2	24.9	19.4	24.7
6	30	427.5	12.1	21.2	3.1	24.9	18.9	24.3
7	35	427.5	12.0	21.0	3.2	24.5	18.8	24.2
8	40	420.6	11.9	20.9	3.3	24.4	18.7	24.1
9	45	420.6	11.8	20.8	3.2	24.3	18.6	24.0
10	50	420.6	11.7	20.6	3.2	24.1	18.4	23.8
11	55	420.6	11.7	20.5	3.3	24.0	18.3	23.8
12	60	420.6	11.7	20.4	3.2	24.0	18.1	23.8
13	65	420.6	11.6	20.3	3.3	24.4	18.0	23.6
14	70	420.6	11.6	20.2	3.3	24.0	18.0	23.6
15	75	413.7	11.5	20.2	3.4	24.0	17.7	23.5
16	80	413.7	11.5	20.2	3.2	24.1	17.9	23.4
17	85	413.7	11.5	20.2	3.3	24.2	17.8	23.5
18	90	413.7	11.4	20.1	3.3	24.2	17.8	23.5
19	95	413.7	11.4	20.1	3.2	23.9	17.8	23.5
20	100	413.7	11.4	20.1	3.2	24.0	17.8	23.5
21	105	413.7	11.3	20.0	3.2	23.8	17.9	23.5
22	110	413.7	11.3	20.0	3.2	23.9	17.8	23.4
23	115	413.7	11.3	20.1	3.2	23.9	17.8	23.4
24	120	413.7	11.3	20.1	3.2	23.9	17.9	23.4
25	125	413.7	11.3	20.1	3.3	23.8	17.8	23.3
26	130	413.7	11.4	20.1	3.2	24.0	18.0	23.3
27	135	413.7	11.4	20.1	3.1	23.8	17.9	23.3
28	140	413.7	11.4	20.1	3.2	23.7	17.8	23.2
29	145	413.7	11.3	20.0	3.3	23.9	17.7	23.3
30	150	413.7	11.2	20.0	3.2	23.8	17.7	23.2
31	155	413.7	11.2	19.9	3.2	23.8	17.6	23.1
32	160	413.7	11.3	19.8	3.3	23.7	17.6	23.1
33	165	413.7	11.3	19.9	3.2	23.7	17.7	23.1
34	170	413.7	11.2	19.8	3.3	23.7	17.6	23.1
35	175	413.7	11.1	19.7	3.3	23.7	17.5	23.1
36	180	413.7	11.1	19.7	3.4	23.6	17.5	23.1
37	185	413.7	10.9	19.7	3.2	23.7	17.6	23.1
38	190	413.7	11.0	19.8	3.3	23.6	17.6	23.0
39	195	413.7	11.1	19.8	3.3	23.5	17.6	22.9
40	200	413.7	11.1	19.8	3.2	23.7	17.7	23.0

Tabel C.1.4 Data Evaporator Isobutan 100%

No	Waktu	P	T _{inlet}	T _{outlet}	V _{udara}	T _{inlet udara}	T _{outlet udara}	T _{ruangan}
	menit	kpa	(^o C)	(^o C)	m/s	(^o C)	(^o C)	(^o C)
1	5	172.4	19.6	23.1	4.53	26.9	21.1	26.0
2	10	172.4	19.9	22.5	4.48	26.5	20.5	25.4
3	15	172.4	19.8	21.5	4.47	26.1	20.2	25.0
4	20	165.5	19.7	21.0	4.43	26.1	20.0	25.0
5	25	165.5	19.6	20.7	4.45	25.9	19.9	24.8
6	30	165.5	19.5	20.1	4.10	25.7	19.8	24.7
7	35	165.5	19.2	19.8	4.11	25.8	19.6	24.6
8	40	165.5	19.2	19.8	4.06	25.8	19.6	24.5
9	45	165.5	19.2	19.7	4.04	25.6	19.5	24.5
10	50	165.5	19.0	19.6	4.05	25.5	19.4	24.5
11	55	165.5	19.0	19.5	4.07	25.5	19.4	24.4
12	60	165.5	19.0	19.4	4.20	25.6	19.4	24.3
13	65	165.5	19.0	19.3	4.08	25.4	19.3	24.2
14	70	165.5	18.9	19.3	4.55	25.4	19.2	24.3
15	75	165.5	18.8	19.3	4.51	25.5	19.3	24.3
16	80	165.5	18.9	19.3	4.6	25.4	19.3	24.3
17	85	165.5	18.9	19.3	4.63	25.5	19.2	24.2
18	90	165.5	18.8	19.3	4.67	25.5	19.2	24.3
19	95	165.5	18.8	19.3	4.65	25.4	19.2	24.1
20	100	165.5	18.8	19.3	4.51	25.3	19.2	24.1
21	105	165.5	18.8	19.2	4.65	25.3	19.2	24.1
22	110	165.5	18.8	19.1	4.70	25.3	19.1	24.1
23	115	165.5	18.8	19.1	4.08	25.3	19.1	24.1
24	120	165.5	18.7	19.1	4.09	25.4	19.1	24.1
25	125	165.5	18.8	19.1	4.10	25.6	19.1	24.1
26	130	165.5	18.8	19.1	4.02	25.4	19.1	24.0
27	135	165.5	18.8	19.0	4.40	25.2	19.1	24.1
28	140	165.5	18.7	19.1	4.23	25.4	19.1	24.1
29	145	165.5	18.8	19.1	4.26	25.6	19.1	24.1
30	150	165.5	18.8	19.1	4.46	25.6	19.1	24.1
31	155	165.5	18.7	19.1	4.47	25.5	19.2	24.1
32	160	165.5	18.8	19.0	4.37	25.3	19.1	24.0
33	165	165.5	18.6	19.0	4.34	25.3	19.1	24.0
34	170	165.5	18.6	19.0	4.25	25.4	19.0	24.0
35	175	165.5	18.7	19.0	4.27	25.5	19.0	24.0
36	180	165.5	18.7	18.9	4.35	25.5	19.0	24.0
37	185	165.5	18.7	18.9	4.13	25.3	19.0	24.0
38	190	165.5	18.6	18.9	4.02	25.3	19.0	23.9
39	195	165.5	18.6	18.9	4.06	25.3	18.9	23.9
40	200	165.5	18.6	18.8	4.70	25.3	19.0	23.9

Tabel C.1.5 Data Evaporator Propan 90% + 10%

No	Waktu	P	T _{inlet}	T _{outlet}	V _{udara}	T _{inlet udara}	T _{outlet udara}	T _{ruangan}
	menit	kpa	(^o C)	(^o C)	m/s	(^o C)	(^o C)	(^o C)
1	5	344.7	11.3	24.0	5.35	27.2	26.4	27.3
2	10	344.7	11.0	24.0	5.45	26.6	24.5	26.6
3	15	351.6	10.9	23.7	5.50	26.3	20.2	26.3
4	20	351.6	10.8	23.4	5.55	26.3	19.7	26.0
5	25	351.6	10.6	23.2	5.55	26.1	19.6	25.9
6	30	351.6	10.4	22.9	5.65	25.7	19.7	25.7
7	35	351.6	10.3	22.8	5.65	25.6	19.7	25.6
8	40	351.6	10.3	22.7	5.65	25.7	19.9	25.5
9	45	351.6	10.3	22.6	5.60	25.6	19.7	25.5
10	50	351.6	10.2	22.5	5.55	25.4	19.6	25.4
11	55	351.6	10.1	22.4	5.55	25.2	19.5	25.3
12	60	351.6	10.3	22.2	5.50	25.1	20.0	24.8
13	65	344.7	10.2	22.2	5.40	25.3	19.9	24.6
14	70	344.7	10.1	22.1	5.25	25.1	19.9	24.6
15	75	344.7	10.2	22.1	5.45	25.1	19.8	24.4
16	80	344.7	10.2	22.0	5.30	25.1	19.8	24.4
17	85	344.7	10.2	21.9	5.25	24.9	19.7	24.5
18	90	344.7	10.2	21.8	5.05	24.8	19.7	24.4
19	95	344.7	10.2	21.7	5.10	24.7	19.6	24.3
20	100	344.7	10.1	21.6	5.15	24.7	19.5	24.2
21	105	344.7	10.1	21.6	5.05	24.7	19.4	24.2
22	110	344.7	10.1	21.6	5.00	24.7	19.3	24.1
23	115	344.7	10.0	21.6	5.00	24.7	19.3	24.1
24	120	344.7	10.1	21.6	4.99	24.9	19.3	24.2
25	125	344.7	10.1	21.6	4.95	24.7	19.3	24.1
26	130	344.7	10.1	21.5	4.94	24.8	19.2	24.0
27	135	344.7	10.1	21.5	4.97	24.7	19.2	24.0
28	140	344.7	10.1	21.5	4.99	24.7	19.2	23.9
29	145	344.7	10.1	21.5	5.00	24.6	19.1	23.9
30	150	344.7	9.9	21.4	4.97	24.6	19.1	23.9
31	155	344.7	10	21.4	4.95	24.7	18.9	23.8
32	160	344.7	9.9	21.4	4.94	24.4	19.9	23.8
33	165	344.7	9.9	21.3	4.89	24.4	18.9	23.7
34	170	344.7	9.9	21.3	4.91	24.5	19.8	23.8
35	175	344.7	9.9	21.3	4.94	24.4	19.7	23.8
36	180	344.7	9.9	21.2	4.89	24.6	18.8	23.6
37	185	344.7	9.9	21.2	4.89	24.4	19.8	23.7
38	190	344.7	9.9	21.2	4.80	24.8	18.8	23.7
39	195	344.7	9.9	21.2	4.86	24.3	19.8	23.8
40	200	344.7	9.9	21.2	4.75	24.3	18.9	23.7

Tabel C.1.6 Data Evaporator Propan 80% + 20%

No	Waktu	P	T _{inlet}	T _{outlet}	V _{udara}	T _{inlet udara}	T _{outlet udara}	T _{ruangan}
	menit	kpa	(^o C)	(^o C)	m/s	(^o C)	(^o C)	(^o C)
1	5	358.5	14.4	25.0	5.35	27.7	21.7	26.1
2	10	358.5	13.8	24.1	5.45	26.9	20.7	25.1
3	15	358.5	13.7	23.3	5.50	26.5	20.0	24.5
4	20	358.5	13.2	22.7	5.55	26.2	19.3	24.0
5	25	358.5	12.8	22.2	5.55	25.9	18.8	23.7
6	30	358.5	12.8	21.8	5.65	25.7	18.3	23.4
7	35	358.5	12.7	21.4	5.65	25.5	17.9	23.1
8	40	358.5	12.5	21.2	5.65	25.2	17.7	23.0
9	45	358.5	12.6	21.0	5.60	25.1	17.6	22.8
10	50	358.5	12.3	20.9	5.55	24.9	17.5	22.7
11	55	358.5	12.2	20.6	5.55	24.8	17.3	22.5
12	60	358.5	12.3	20.5	5.50	24.6	17.1	22.4
13	65	358.5	12.3	20.4	5.40	24.7	17.1	22.4
14	70	358.5	12.2	20.3	5.25	24.5	17.0	22.3
15	75	358.5	12.2	20.3	5.45	24.5	17.0	22.3
16	80	358.5	12.2	20.2	5.30	24.4	16.9	22.2
17	85	358.5	12.2	20.1	5.25	24.4	16.9	22.1
18	90	358.5	12.1	20.1	5.05	24.4	16.8	22.1
19	95	358.5	12.0	20.0	5.10	24.3	16.7	22.1
20	100	358.5	11.8	20.0	5.15	24.5	16.8	22.2
21	105	358.5	12.1	20.0	5.05	24.4	16.7	22.0
22	110	358.5	12.2	19.9	5.00	24.3	16.6	22.0
23	115	358.5	12.1	19.9	5.00	24.4	16.6	21.9
24	120	358.5	12.0	19.9	4.99	24.2	16.6	21.9
25	125	358.5	12.1	19.9	4.95	24.2	16.5	21.9
26	130	358.5	12.1	19.9	4.94	24.1	16.6	21.9
27	135	358.5	12.0	19.8	4.97	24.1	16.5	21.9
28	140	358.5	12.0	19.8	4.99	24.3	16.6	21.8
29	145	358.5	12.1	19.8	5.00	24.5	16.5	21.9
30	150	358.5	12.0	19.8	4.97	24.4	16.5	21.8
31	155	358.5	12.1	19.8	4.95	24.3	16.5	21.8
32	160	358.5	12.0	19.8	4.94	24.3	16.5	21.8
33	165	358.5	11.9	19.7	4.89	24.2	16.4	21.7
34	170	358.5	11.9	19.7	4.91	24.3	16.4	21.8
35	175	358.5	12.0	19.8	4.94	24.2	16.5	21.7
36	180	358.5	12.0	19.8	4.89	24.3	16.4	21.7
37	185	358.5	11.9	19.7	4.89	24.3	16.4	21.6
38	190	358.5	11.9	19.7	4.80	24.1	16.4	21.6
39	195	358.5	12.0	19.7	4.86	24.1	16.3	21.4
40	200	358.5	11.8	19.6	4.75	23.9	16.2	21.4

Tabel C.1.7 Data Evaporator Propan 70% + 30%

No	Waktu	P	T _{inlet}	T _{outlet}	V _{udara}	T _{inlet udara}	T _{outlet udara}	T _{ruangan}
	menit	kpa	(^o C)	(^o C)	m/s	(^o C)	(^o C)	(^o C)
1	5	399.9	16.8	22.8	4.5	26.9	20.1	27.2
2	10	406.8	16.4	21.5	4.4	26.3	19.1	25.9
3	15	406.8	16.2	20.6	4.5	26.0	18.5	25.8
4	20	406.8	15.9	19.6	4.7	25.6	18.0	25.5
5	25	406.8	15.5	18.9	4.5	25.5	17.6	25.2
6	30	406.8	15.3	18.6	4.4	25.3	17.4	24.9
7	35	406.8	15.1	18.3	4.2	25.1	17.2	25.0
8	40	365.4	15.0	18.1	4.2	24.9	17.0	24.5
9	45	365.4	14.9	18.0	4.3	24.8	17.0	24.5
10	50	365.4	14.8	17.9	4.2	24.7	16.9	24.2
11	55	365.4	14.8	17.8	4.3	24.6	16.8	24.3
12	60	365.4	14.7	17.7	4.7	24.5	16.7	24.2
13	65	365.4	14.7	17.6	4.6	24.5	16.7	24.3
14	70	365.4	14.6	17.6	4.6	24.5	16.6	24.3
15	75	365.4	14.6	17.6	4.6	24.4	16.6	24.1
16	80	365.4	14.7	17.6	4.6	24.3	16.6	24.2
17	85	365.4	14.6	17.6	4.6	24.4	16.6	24.0
18	90	365.4	14.6	17.5	4.6	24.3	16.5	24.0
19	95	365.4	14.6	17.5	4.6	24.3	16.6	23.9
20	100	365.4	14.6	17.5	4.5	24.3	16.5	23.8
21	105	365.4	14.2	17.5	4.6	24.3	16.5	23.8
22	110	365.4	14.5	17.4	4.6	24.3	16.5	23.8
23	115	365.4	14.5	17.5	4.6	24.2	16.6	23.6
24	120	365.4	14.5	17.4	4.4	24.3	16.5	23.7
25	125	365.4	14.6	17.5	4.4	24.2	16.6	23.8
26	130	365.4	14.6	17.4	4.4	24.2	16.5	23.7
27	135	365.4	14.4	17.3	4.3	24.2	16.4	23.4
28	140	365.4	14.3	17.2	4.3	24.1	16.3	23.4
29	145	365.4	14.2	17.1	4.3	24.0	16.2	23.4
30	150	351.6	14.1	17.0	4.3	24.0	16.2	23.3
31	155	351.6	14.0	16.9	4.3	23.9	16.1	23.3
32	160	351.6	14.0	16.9	4.3	23.8	16.1	23.4
33	165	351.6	14.0	16.9	4.4	23.7	16.0	23.2
34	170	351.6	14.1	16.9	4.3	23.7	16.0	23.2
35	175	351.6	14.1	16.9	4.2	23.8	16.0	23.2
36	180	351.6	14.0	16.8	4.1	23.7	15.9	23.2
37	185	351.6	14.0	16.8	4.1	23.7	15.9	23.1
38	190	351.6	14.0	16.8	4.1	23.7	15.9	23.1
39	195	351.6	13.9	16.7	4.1	23.7	15.9	23.1
40	200	351.6	13.9	16.7	4.3	23.8	15.9	22.9

Tabel C.1.8 Data Evaporator Propan 50% + 50%

No	Waktu	P	T _{inlet}	T _{outlet}	V _{udara}	T _{inlet udara}	T _{outlet udara}	T _{ruangan}
	menit	kpa	(^o C)	(^o C)	m/s	(^o C)	(^o C)	(^o C)
1	5	489.5	19.3	22.0	3.61	27.0	21.2	27.6
2	10	489.5	19.0	21.4	3.74	26.6	20.7	27.0
3	15	489.5	18.7	21.1	3.82	26.4	20.4	26.9
4	20	482.6	18.6	20.9	3.82	26.3	20.2	26.7
5	25	475.7	18.4	20.7	3.77	26.3	20.0	26.6
6	30	475.7	18.3	20.6	3.81	26.2	19.9	26.5
7	35	475.7	18.0	20.4	3.78	26.0	19.7	26.4
8	40	475.7	17.9	20.2	3.70	26.0	19.6	26.2
9	45	475.7	17.9	20.1	3.78	25.9	19.5	26.2
10	50	475.7	17.9	20.0	3.85	25.9	19.5	26.1
11	55	475.7	17.8	20.0	3.8	25.9	19.4	26.1
12	60	468.8	17.9	20.0	3.72	25.9	19.4	26.1
13	65	468.8	17.9	20.0	3.82	25.8	19.4	26.0
14	70	468.8	17.9	20.0	3.74	25.9	19.4	26.0
15	75	468.8	17.8	19.9	3.73	25.9	19.4	26.0
16	80	468.8	17.9	20.0	3.75	26.0	19.3	26.0
17	85	468.8	17.9	19.9	3.73	25.8	19.3	25.9
18	90	468.8	17.8	19.9	3.91	25.8	19.3	25.9
19	95	468.8	17.7	19.9	3.92	25.7	19.2	26.0
20	100	468.8	17.8	19.9	3.95	25.8	19.2	26.0
21	105	468.8	17.7	19.8	3.98	25.7	19.2	25.9
22	110	468.8	17.8	19.8	3.97	25.7	19.2	25.9
23	115	468.8	17.7	19.8	3.97	25.7	19.2	25.9
24	120	461.9	17.8	19.8	3.97	25.7	19.2	25.9
25	125	461.9	17.7	19.8	3.97	25.7	19.2	25.9
26	130	461.9	17.8	19.8	3.97	25.7	19.2	25.9
27	135	461.9	17.7	19.8	3.97	25.7	19.2	25.9
28	140	461.9	17.8	19.8	3.97	25.7	19.2	25.9
29	145	461.9	17.7	19.8	3.97	25.7	19.2	25.9
30	150	461.9	17.7	19.7	3.97	25.7	19.2	25.9
31	155	461.9	17.7	19.7	3.97	25.7	19.2	25.9
32	160	461.9	17.7	19.7	3.97	25.7	19.2	25.9
33	165	455.1	17.6	19.7	3.97	25.7	19.2	25.9
34	170	455.1	17.6	19.7	3.97	25.7	19.2	25.9
35	175	455.1	17.7	19.7	3.97	25.7	19.2	25.9
36	180	455.1	17.8	19.7	3.97	25.7	19.2	25.9
37	185	455.1	17.7	19.7	3.97	25.7	19.2	25.9
38	190	455.1	17.7	19.7	3.97	25.7	19.2	25.9
39	195	441.3	17.6	19.6	3.97	25.7	19.2	25.9
40	200	441.3	17.6	19.6	3.97	25.7	19.2	25.9

Lampiran D

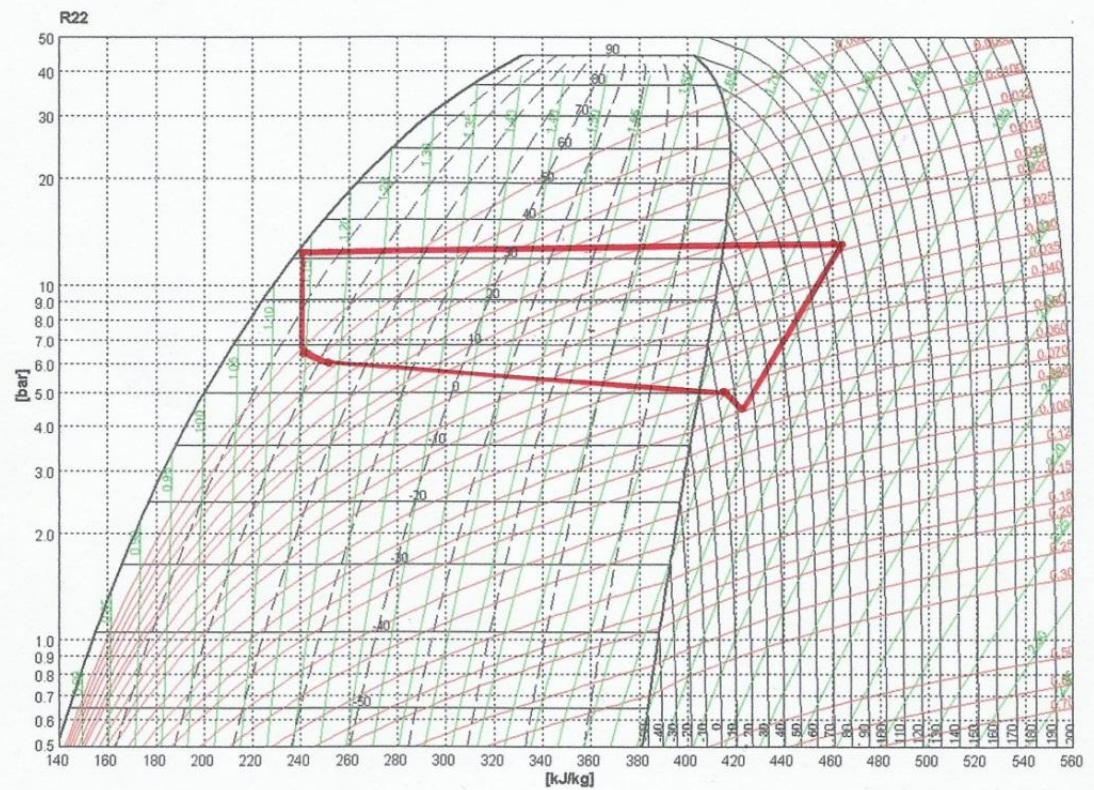

Gambar D.1.1 Diagram P-h R22 pada menit 150

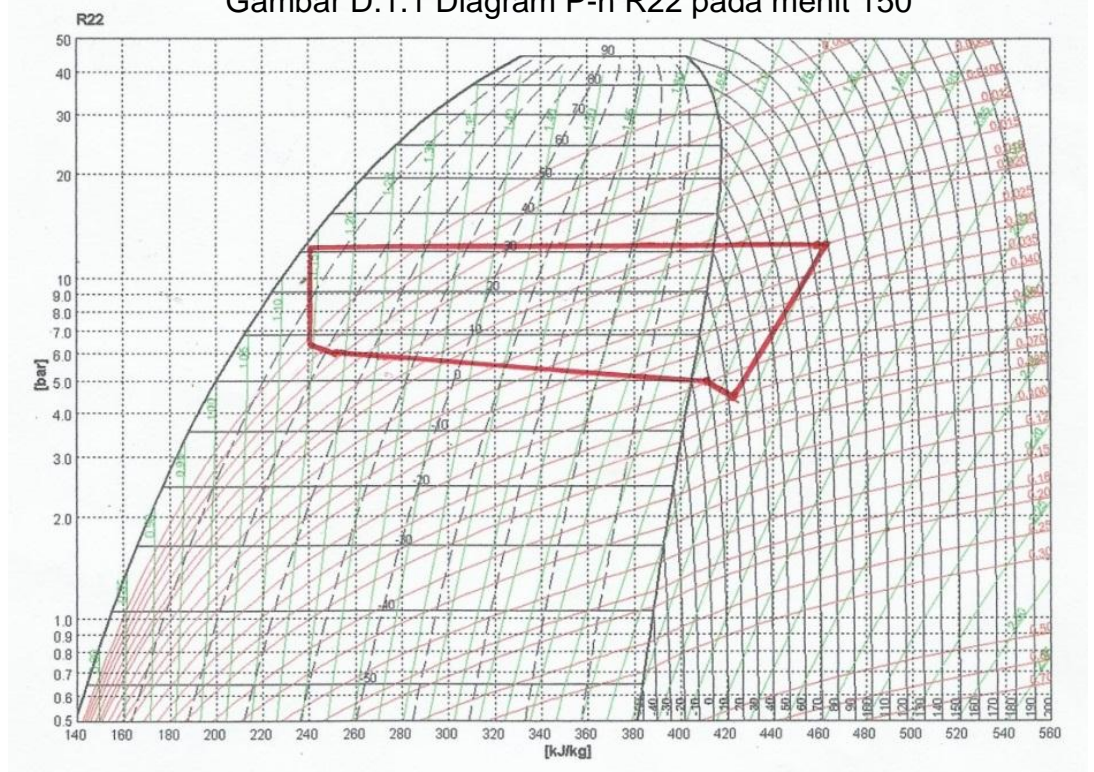

Gambar D.1.2 Diagram P-h R22 pada menit 155

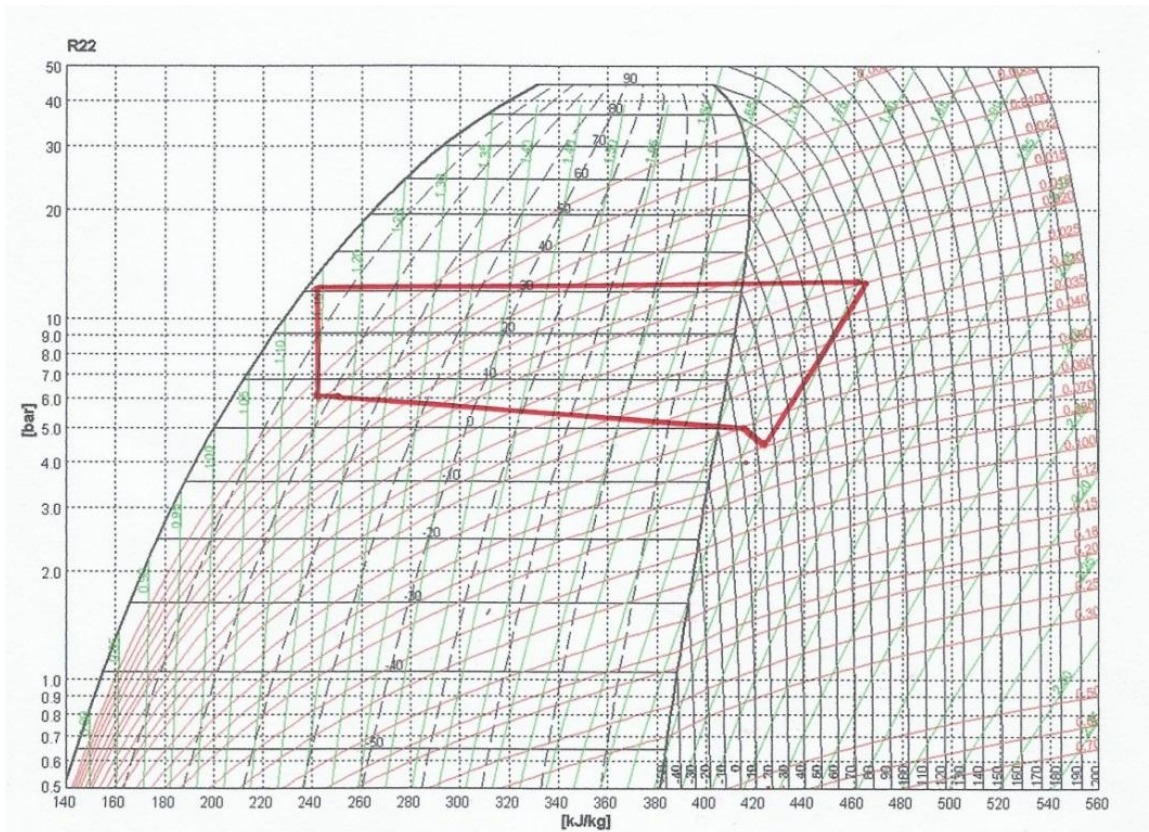

Gambar D.1.3 Diagram P-h R22 pada menit 160

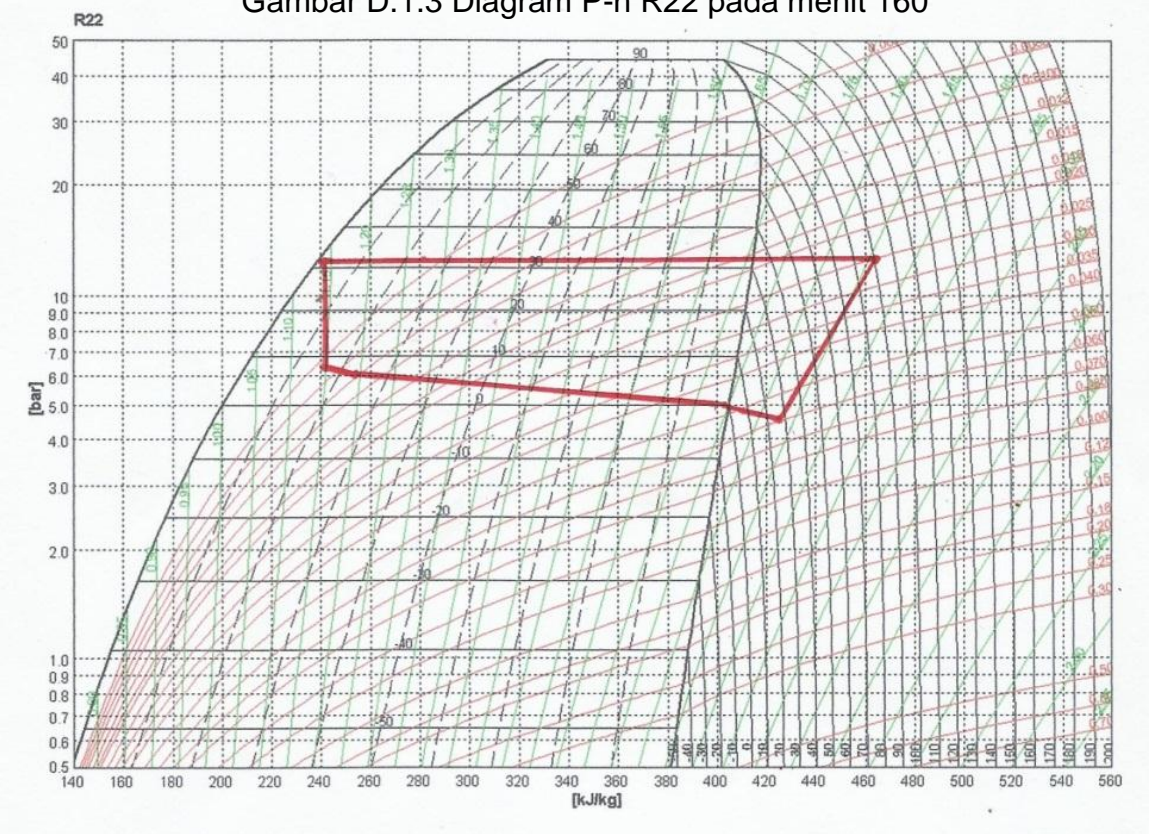

Gambar D.1.4 Diagram P-h R22 pada menit 165

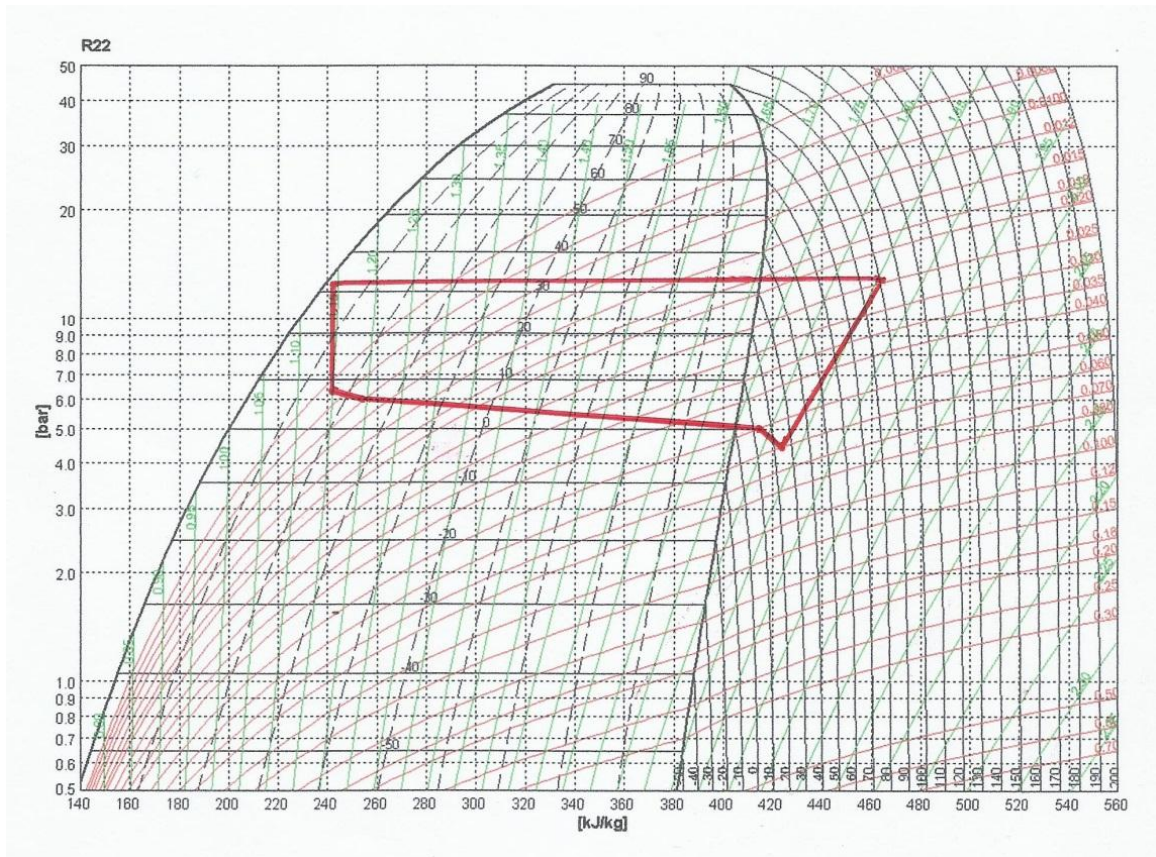

Gambar D.1.5 Diagram P-h R22 pada menit 170

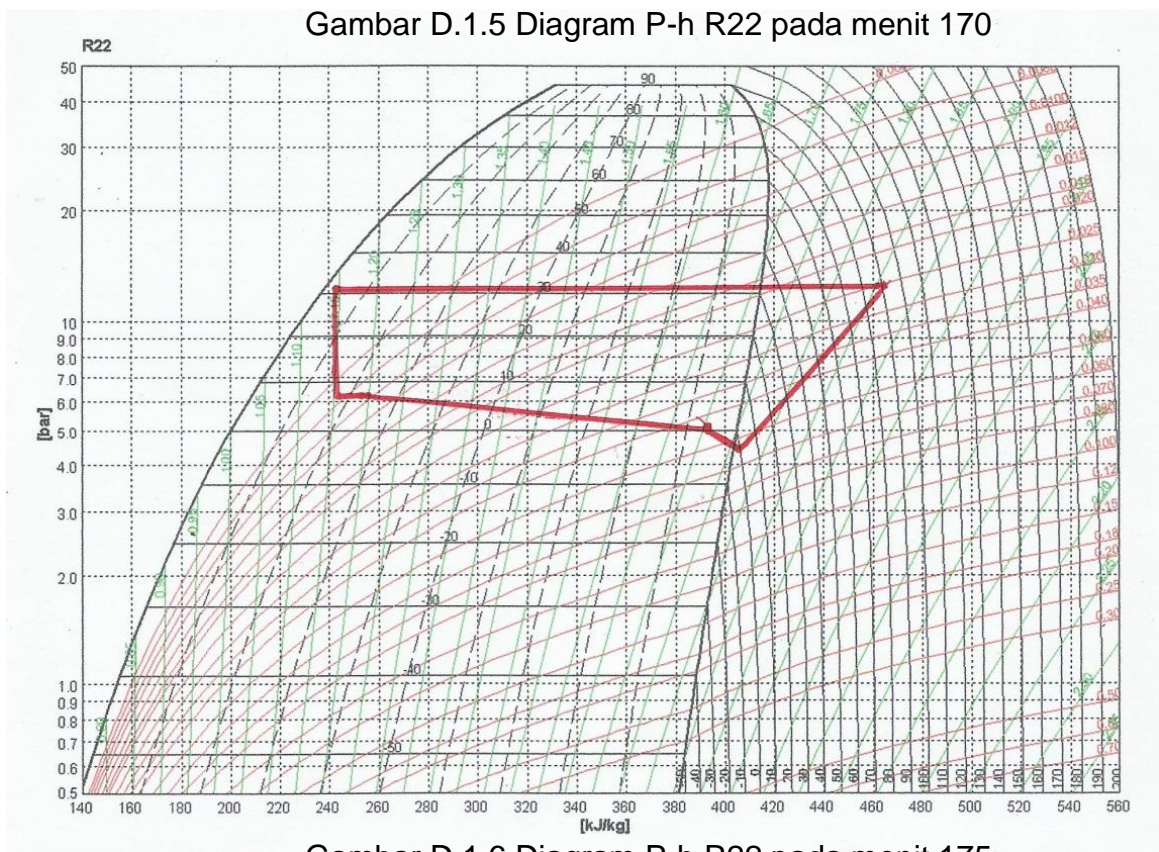

Gambar D.1.6 Diagram P-h R22 pada menit 175

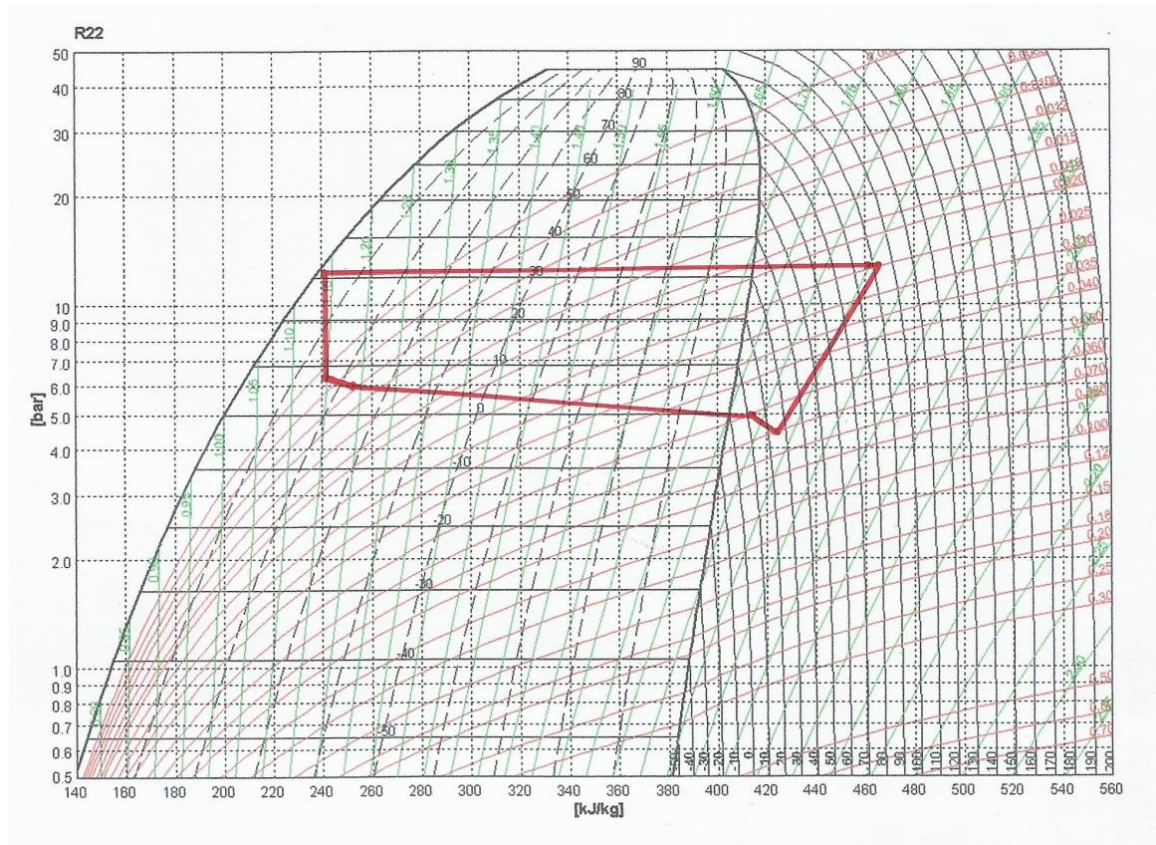

Gambar D.1.7 Diagram P-h R22 pada menit 180

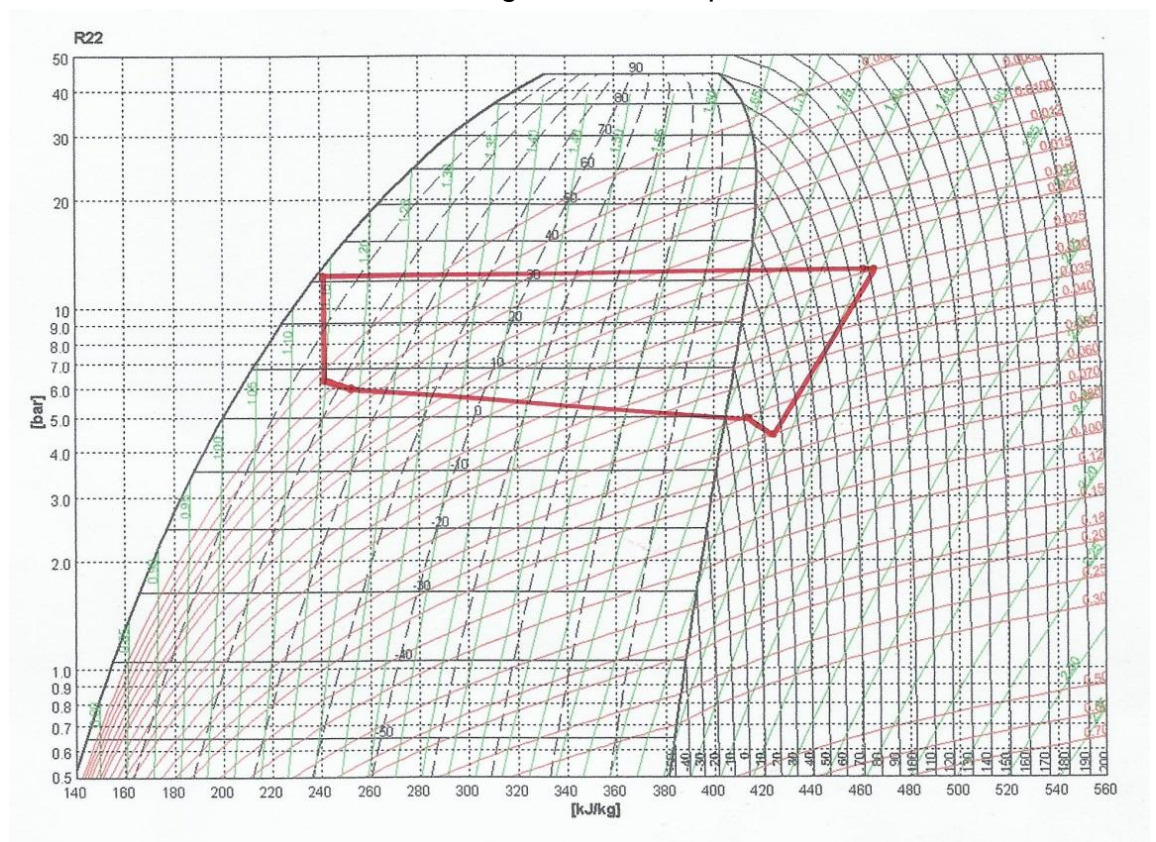

Gambar D.1.8 Diagram P-h R22 pada menit 185

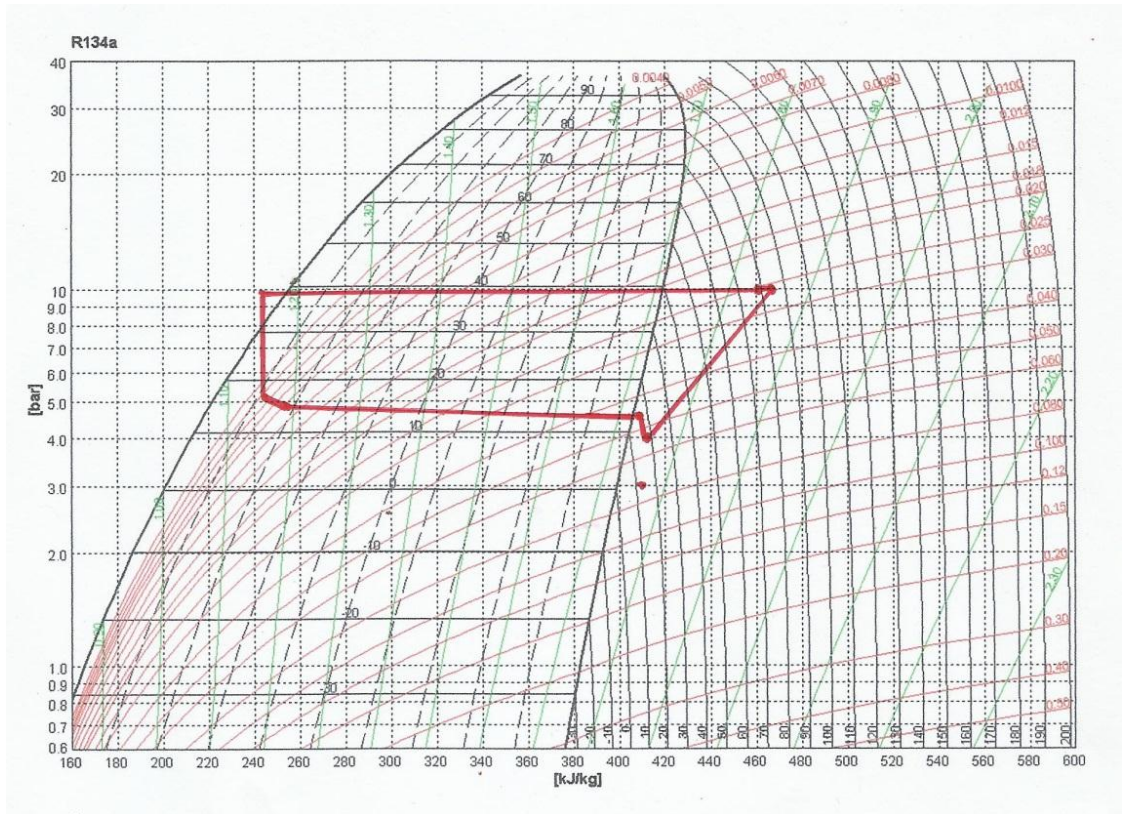
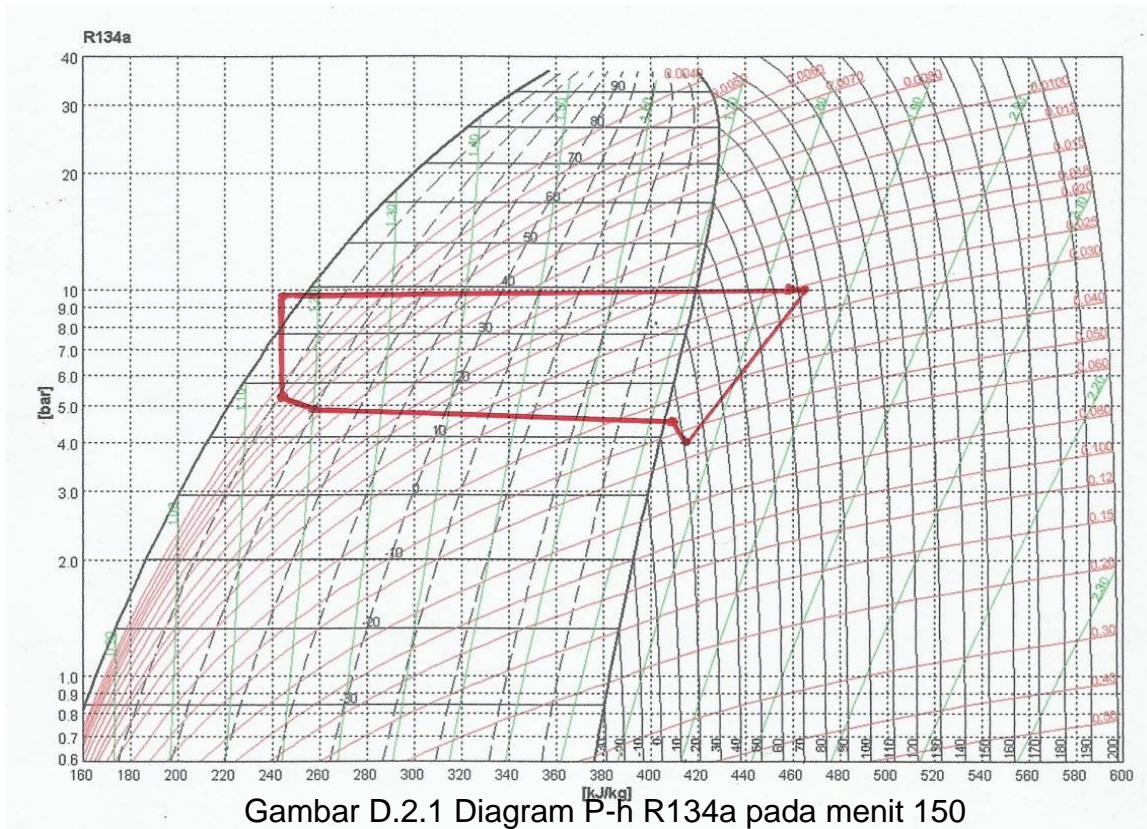

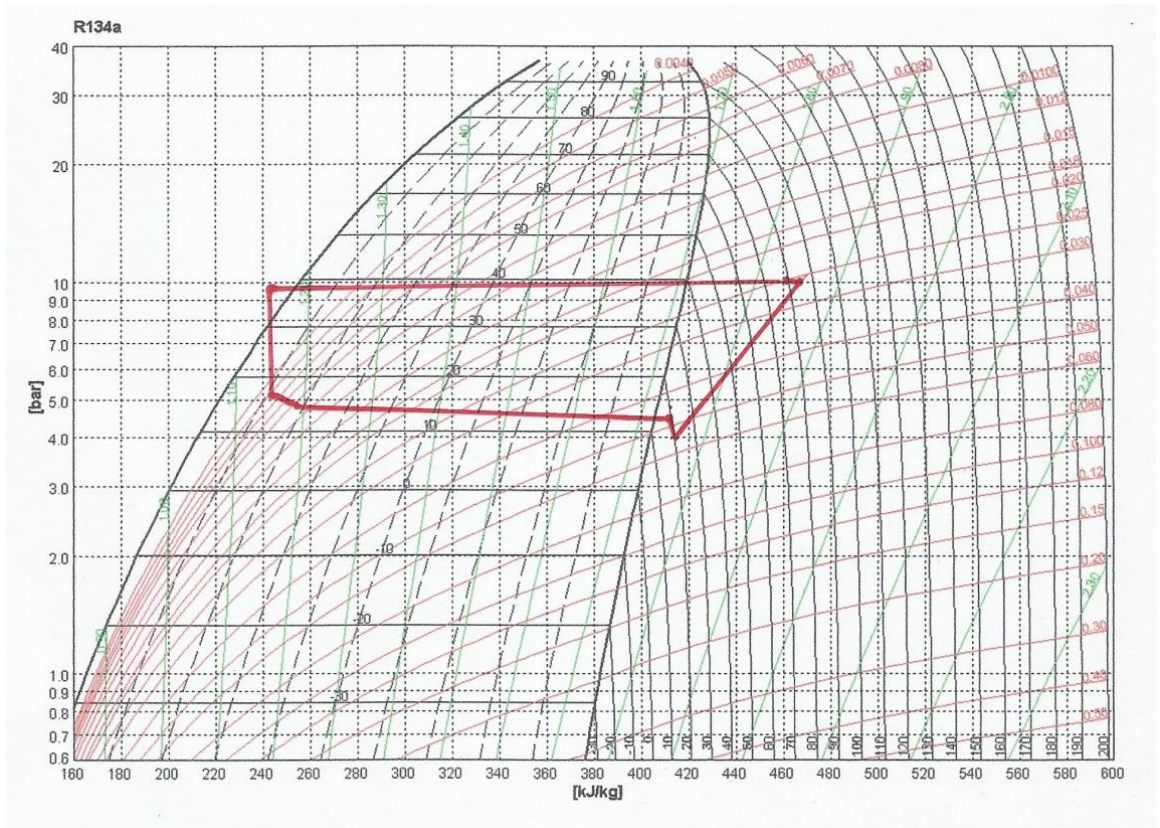

Gambar D.2.3 Diagram P-h R134a pada menit 160

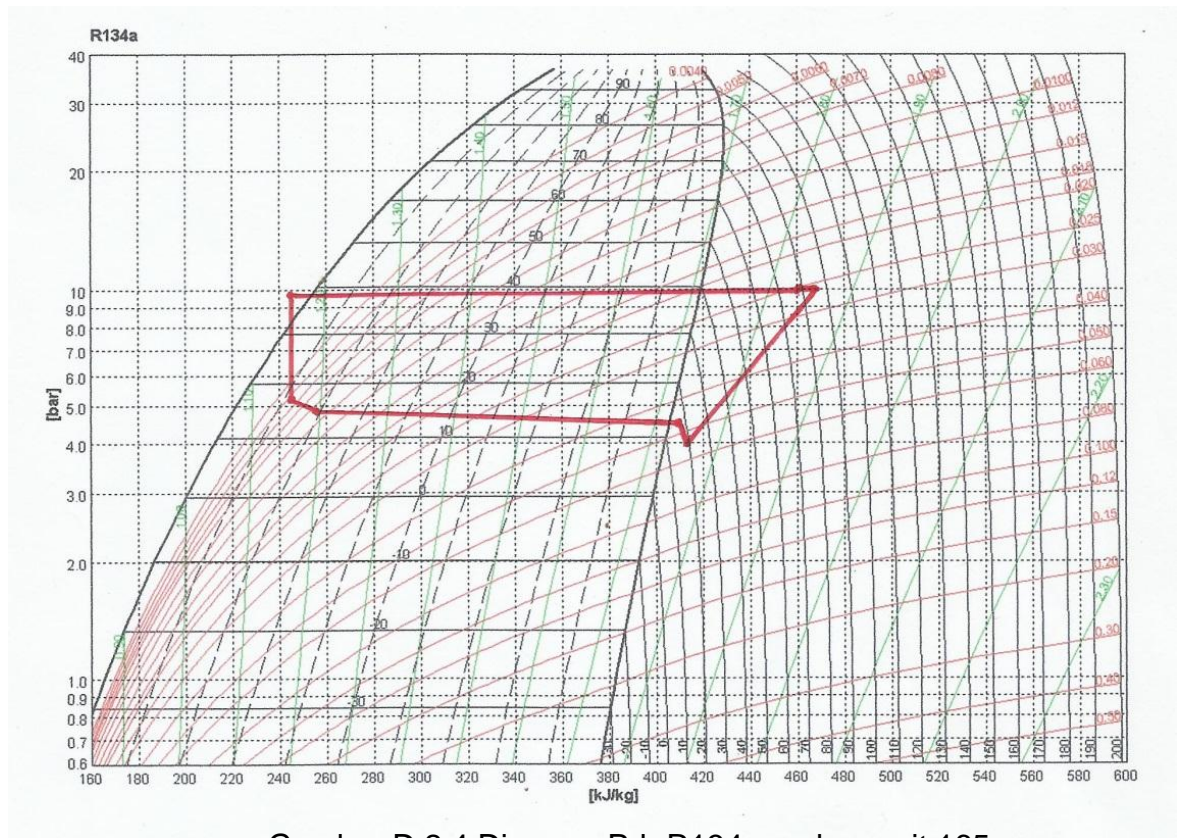

Gambar D.2.4 Diagram P-h R134a pada menit 165

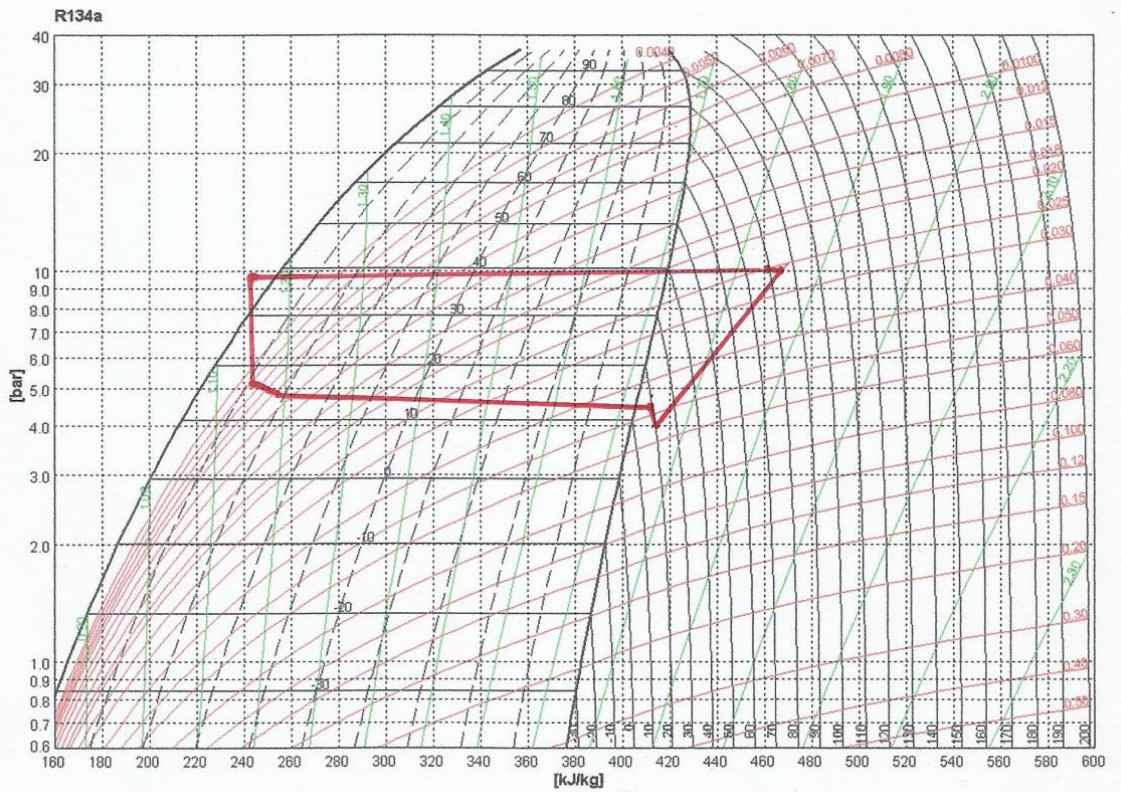

Gambar D.2.5 Diagram P-h R134a pada menit 170

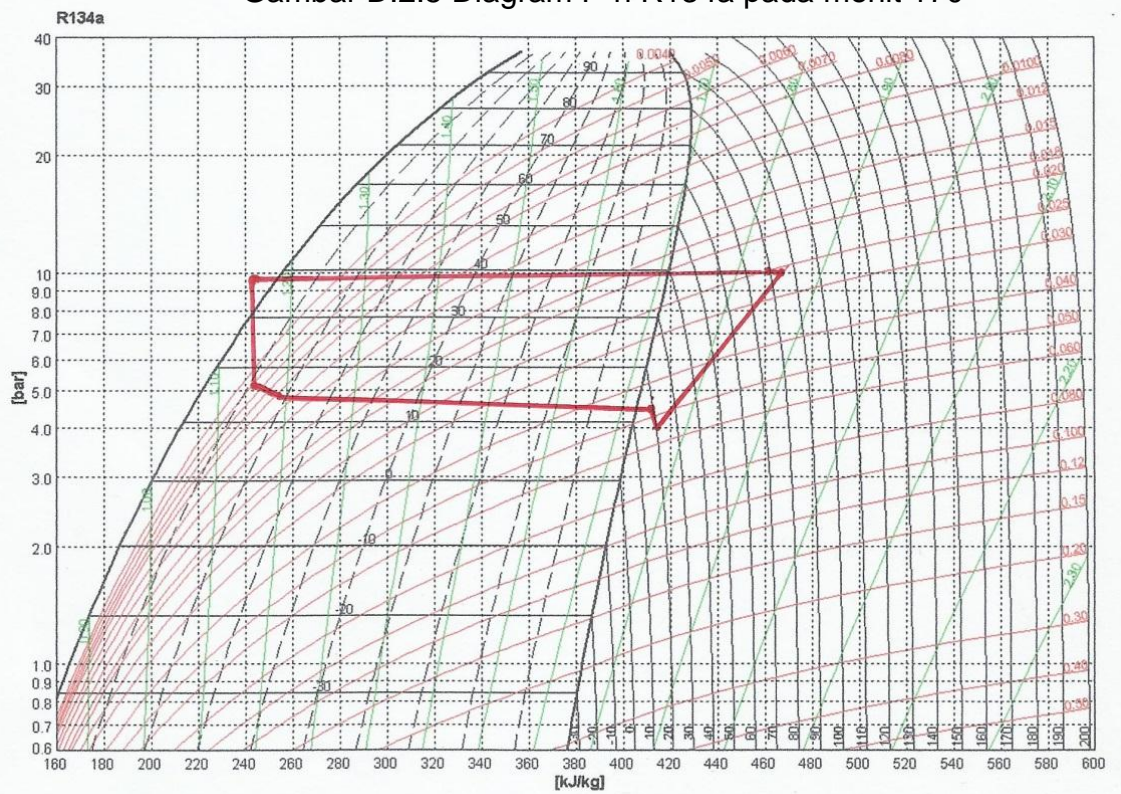

Gambar D.2.6 Diagram P-h R134a pada menit 175

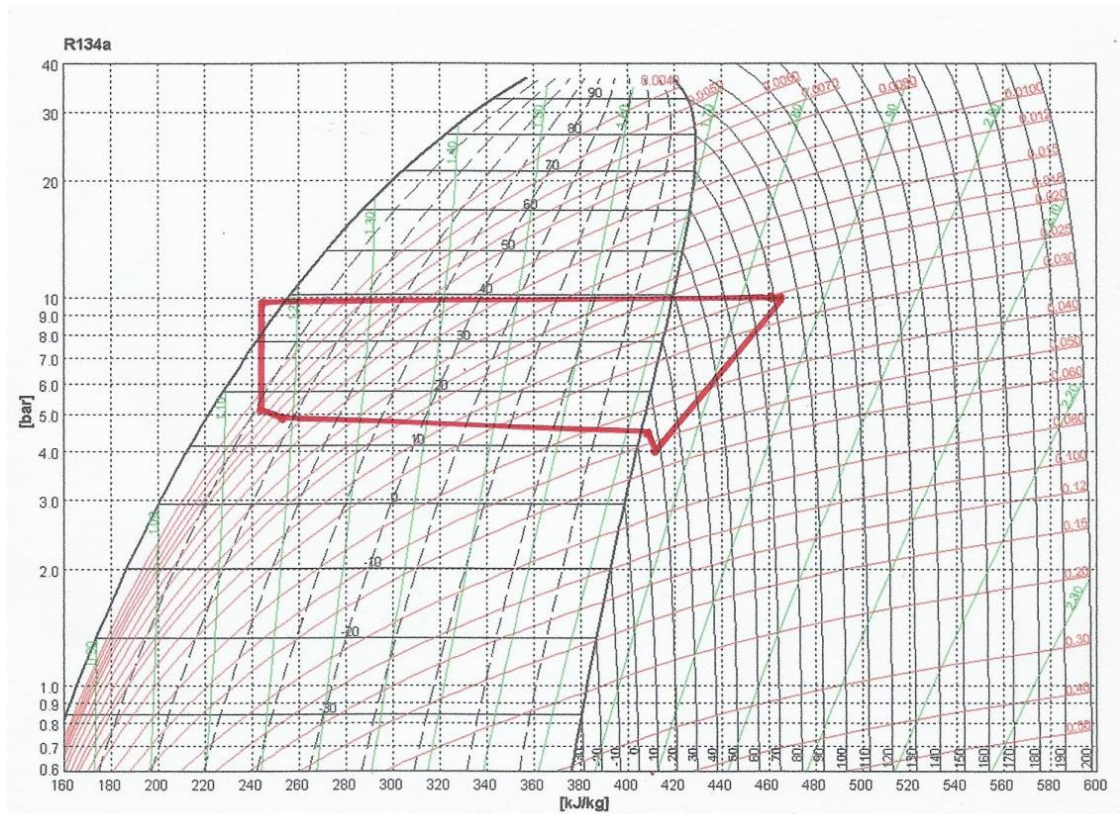

Gambar D.2.7 Diagram P-h R134a pada menit 180

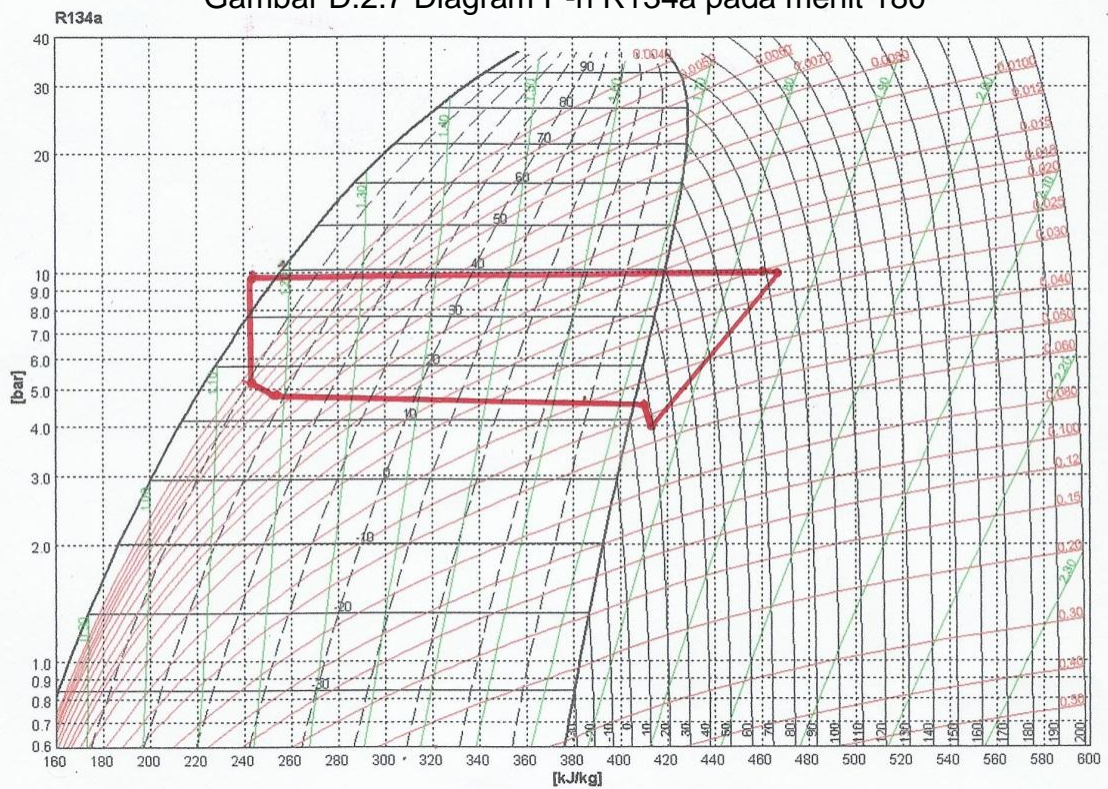

Gambar D.2.7 Diagram P-h R134a pada menit 185

Lampiran E

Tabel D.1 Hasil Perhitungan refrigeran sintesis R22

No	t	ρ	\dot{m}_{ud}	Q_{evap}	q_{re}	\dot{m}_{ref}	w_c	W_c	Q_c	COP	T_r
	menit	kg/m^3	kg/s	kW	kJ/kg	kg/s	kJ/kg	kW	kW		$^{\circ}C$
1	5	5.824	0.173	2.848	185.20	0.0154	37.20	0.572	3.420	4.978	26.9
2	10	5.853	0.178	2.829	184.50	0.0153	37.30	0.572	3.401	4.946	26.0
3	15	5.959	0.177	2.810	184.20	0.0153	37.50	0.572	3.382	4.912	25.8
4	20	5.971	0.182	2.801	184.10	0.0152	37.60	0.572	3.373	4.896	24.9
5	25	5.981	0.183	2.799	184.00	0.0152	37.60	0.572	3.371	4.894	24.6
6	30	5.989	0.180	2.767	183.80	0.0151	38.00	0.572	3.339	4.837	24.4
7	35	5.998	0.182	2.759	183.80	0.0150	38.10	0.572	3.331	4.824	24.1
8	40	6.006	0.180	2.744	183.70	0.0149	38.30	0.572	3.316	4.796	24.0
9	45	5.944	0.177	2.729	183.70	0.0149	38.50	0.572	3.301	4.771	23.9
10	50	5.934	0.179	2.735	183.60	0.0149	38.40	0.572	3.307	4.781	23.8
11	55	5.944	0.178	2.702	183.30	0.0147	38.80	0.572	3.274	4.724	23.7
12	60	5.946	0.178	2.702	183.30	0.0147	38.80	0.572	3.274	4.724	23.7
13	65	5.948	0.177	2.709	183.30	0.0148	38.70	0.572	3.281	4.736	23.6
14	70	5.948	0.180	2.702	183.30	0.0147	38.80	0.572	3.274	4.724	23.5
15	75	5.950	0.178	2.702	183.30	0.0147	38.80	0.572	3.274	4.724	23.5
16	80	5.952	0.179	2.704	183.40	0.0147	38.80	0.572	3.276	4.727	23.4
17	85	5.869	0.174	2.752	186.20	0.0148	38.70	0.572	3.324	4.811	23.4
18	90	5.872	0.175	2.745	186.20	0.0147	38.80	0.572	3.317	4.799	23.1
19	95	5.874	0.175	2.744	186.10	0.0147	38.80	0.572	3.316	4.796	22.9
20	100	5.878	0.175	2.748	186.40	0.0147	38.80	0.572	3.320	4.804	22.8
21	105	5.878	0.175	2.690	183.40	0.0147	39.00	0.572	3.262	4.703	22.8
22	110	5.878	0.175	2.690	183.40	0.0147	39.00	0.572	3.262	4.703	22.7
23	115	5.797	0.173	2.677	183.00	0.0146	39.10	0.572	3.249	4.680	22.7
24	120	5.801	0.173	2.679	183.10	0.0146	39.10	0.572	3.251	4.683	22.5
25	125	5.801	0.174	2.679	183.10	0.0146	39.10	0.572	3.251	4.683	22.3
26	130	5.801	0.174	2.674	182.80	0.0146	39.10	0.572	3.246	4.675	22.3
27	135	5.803	0.174	2.681	182.80	0.0147	39.00	0.572	3.253	4.687	22.2
28	140	5.803	0.176	2.673	183.20	0.0146	39.20	0.572	3.245	4.673	22.2
29	145	5.805	0.173	2.673	183.20	0.0146	39.20	0.572	3.245	4.673	22.1
30	150	5.803	0.171	2.685	183.10	0.0147	39.00	0.572	3.257	4.695	21.9
31	155	5.803	0.174	2.687	183.20	0.0147	39.00	0.572	3.259	4.697	21.8
32	160	5.803	0.166	2.670	183.00	0.0146	39.20	0.572	3.242	4.668	21.7
33	165	5.809	0.174	2.674	182.80	0.0146	39.10	0.572	3.246	4.675	21.6
34	170	5.807	0.173	2.674	182.80	0.0146	39.10	0.572	3.246	4.675	21.5
35	175	5.809	0.173	2.674	182.80	0.0146	39.10	0.572	3.246	4.675	21.4
36	180	5.809	0.174	2.683	182.90	0.0147	39.00	0.572	3.255	4.690	21.4
37	185	5.809	0.173	2.674	182.80	0.0146	39.10	0.572	3.246	4.675	21.4
38	190	5.809	0.174	2.662	182.90	0.0146	39.30	0.572	3.234	4.654	21.4
39	195	5.809	0.174	2.670	183.00	0.0146	39.20	0.572	3.242	4.668	21.4
40	200	5.807	0.175	2.670	183.00	0.0146	39.20	0.572	3.242	4.668	21.4

Tabel D.2 Hasil perhitungan refrigeran R134a

No	t	p	\dot{m}_{ud}	Q_{evap}	q_{re}	\dot{m}_{ref}	w_c	W_c	Q_c	COP	T_r
	menit	kg/m ³	kg/s	kW	kJ/kg	kg/s	kJ/kg	kW	kW		°C
1	5	5.244	0.878	1.530	170.90	0.00895	46.70	0.418	3.449	3.660	29.6
2	10	4.875	0.816	1.529	170.80	0.00895	46.70	0.418	3.448	3.657	29.0
3	15	4.803	0.804	1.526	170.80	0.00893	46.80	0.418	3.441	3.650	28.6
4	20	4.730	0.807	1.523	170.90	0.00891	46.90	0.418	3.436	3.644	28.5
5	25	4.733	0.800	1.513	170.50	0.00887	47.10	0.418	3.419	3.620	28.3
6	30	4.654	0.794	1.510	170.90	0.00884	47.30	0.418	3.409	3.613	28.1
7	35	4.658	0.807	1.493	170.40	0.00876	47.70	0.418	3.380	3.572	28.0
8	40	4.577	0.786	1.488	170.20	0.00874	47.80	0.418	3.372	3.561	27.9
9	45	4.579	0.776	1.481	169.70	0.00873	47.90	0.418	3.362	3.543	27.8
10	50	4.581	0.779	1.483	169.90	0.00873	47.90	0.418	3.364	3.547	27.7
11	55	4.582	0.782	1.476	169.80	0.00869	48.10	0.418	3.351	3.530	27.6
12	60	4.584	0.780	1.473	169.90	0.00867	48.20	0.418	3.345	3.525	27.6
13	65	4.503	0.749	1.470	169.90	0.00865	48.30	0.418	3.339	3.518	27.6
14	70	4.503	0.754	1.469	170.10	0.00864	48.40	0.418	3.334	3.514	27.5
15	75	4.505	0.769	1.465	170.00	0.00862	48.50	0.418	3.327	3.505	27.4
16	80	4.506	0.776	1.464	169.90	0.00862	48.50	0.418	3.326	3.503	27.4
17	85	4.506	0.762	1.468	170.30	0.00862	48.50	0.418	3.328	3.511	27.3
18	90	4.508	0.752	1.464	170.20	0.00860	48.60	0.418	3.322	3.502	27.2
19	95	4.510	0.779	1.462	170.30	0.00858	48.70	0.418	3.316	3.497	27.2
20	100	4.511	0.770	1.460	170.40	0.00857	48.80	0.418	3.311	3.492	27.2
21	105	4.511	0.777	1.459	170.30	0.00857	48.80	0.418	3.310	3.490	27.2
22	110	4.511	0.777	1.453	170.30	0.00853	49.00	0.418	3.298	3.476	27.2
23	115	4.511	0.777	1.453	170.30	0.00853	49.00	0.418	3.298	3.476	27.2
24	120	4.511	0.777	1.453	170.30	0.00853	49.00	0.418	3.298	3.476	27.2
25	125	4.511	0.777	1.453	170.30	0.00853	49.00	0.418	3.298	3.476	27.2
26	130	4.511	0.777	1.453	170.30	0.00853	49.00	0.418	3.298	3.476	27.2
27	135	4.511	0.777	1.451	170.40	0.00851	49.10	0.418	3.293	3.470	27.2
28	140	4.511	0.777	1.451	170.40	0.00851	49.10	0.418	3.293	3.470	27.2
29	145	4.511	0.777	1.447	170.30	0.00850	49.20	0.418	3.286	3.461	27.2
30	150	4.511	0.777	1.447	170.30	0.00850	49.20	0.418	3.286	3.461	27.2
31	155	4.511	0.777	1.447	170.30	0.00850	49.20	0.418	3.286	3.461	27.2
32	160	4.511	0.777	1.444	170.30	0.00848	49.30	0.418	3.280	3.454	27.2
33	165	4.511	0.777	1.444	170.30	0.00848	49.30	0.418	3.280	3.454	27.2
34	170	4.511	0.777	1.446	170.50	0.00848	49.30	0.418	3.281	3.458	27.2
35	175	4.511	0.777	1.446	170.50	0.00848	49.30	0.418	3.281	3.458	27.2
36	180	4.511	0.777	1.443	170.50	0.00846	49.40	0.418	3.275	3.451	27.2
37	185	4.511	0.777	1.443	170.50	0.00846	49.40	0.418	3.275	3.451	27.2
38	190	4.511	0.777	1.441	170.60	0.00844	49.50	0.418	3.271	3.446	27.2
39	195	4.511	0.777	1.441	170.60	0.00844	49.50	0.418	3.271	3.446	27.2
40	200	4.511	0.777	1.441	170.60	0.00844	49.50	0.418	3.271	3.446	27.2

Tabel D.3 Hasil perhitungan refrigeran Propan 100%

No	t	ρ	\dot{m}_{ud}	Q_{evap}	q_{re}	\dot{m}_{ref}	w_c	W_c	Q_c	COP	T_r
	menit	kg/m^3	kg/s	kW	kJ/kg	kg/s	kJ/kg	kW	kW		$^{\circ}C$
1	5	4.932	0.844	4.246	569.30	0.00746	59.000	0.440	4.686	9.649	26.4
2	10	4.947	0.852	4.180	569.00	0.00735	59.900	0.440	4.620	9.499	25.6
3	15	5.040	0.866	4.109	568.70	0.00722	60.900	0.440	4.549	9.338	25.1
4	20	5.049	0.894	4.124	568.90	0.00725	60.700	0.440	4.564	9.372	24.9
5	25	5.056	0.874	4.062	568.70	0.00714	61.600	0.440	4.502	9.232	24.7
6	30	5.063	0.842	4.062	568.70	0.00714	61.600	0.440	4.502	9.232	24.3
7	35	5.066	0.878	4.049	568.70	0.00712	61.800	0.440	4.489	9.202	24.2
8	40	4.986	0.891	4.042	568.60	0.00711	61.900	0.440	4.482	9.186	24.1
9	45	4.988	0.873	4.049	568.70	0.00712	61.800	0.440	4.489	9.202	24.0
10	50	4.991	0.873	4.028	568.50	0.00709	62.100	0.440	4.468	9.155	23.8
11	55	4.993	0.876	4.041	568.50	0.00711	61.900	0.440	4.481	9.184	23.8
12	60	4.995	0.874	4.062	568.70	0.00714	61.600	0.440	4.502	9.232	23.8
13	65	4.996	0.882	4.039	568.20	0.00711	61.900	0.440	4.479	9.179	23.6
14	70	4.998	0.901	3.999	568.10	0.00704	62.500	0.440	4.439	9.090	23.6
15	75	4.916	0.892	3.999	568.00	0.00704	62.500	0.440	4.439	9.088	23.5
16	80	4.916	0.855	4.001	568.30	0.00704	62.500	0.440	4.441	9.093	23.4
17	85	4.916	0.865	3.974	568.10	0.00700	62.900	0.440	4.414	9.032	23.5
18	90	4.918	0.866	3.999	568.10	0.00704	62.500	0.440	4.439	9.090	23.5
19	95	4.918	0.852	4.012	568.10	0.00706	62.300	0.440	4.452	9.119	23.5
20	100	4.918	0.855	3.974	568.10	0.00700	62.900	0.440	4.414	9.032	23.5
21	105	4.919	0.839	3.999	568.10	0.00704	62.500	0.440	4.439	9.090	23.5
22	110	4.919	0.842	3.974	568.10	0.00700	62.900	0.440	4.414	9.032	23.4
23	115	4.918	0.847	3.974	568.10	0.00700	62.900	0.440	4.414	9.032	23.4
24	120	4.918	0.844	3.999	568.10	0.00704	62.500	0.440	4.439	9.090	23.4
25	125	4.918	0.871	3.986	568.00	0.00702	62.700	0.440	4.426	9.059	23.3
26	130	4.918	0.850	3.961	568.00	0.00697	63.100	0.440	4.401	9.002	23.3
27	135	4.918	0.818	3.974	568.10	0.00700	62.900	0.440	4.414	9.032	23.3
28	140	4.918	0.852	3.972	567.80	0.00700	62.900	0.440	4.412	9.027	23.2
29	145	4.919	0.879	3.987	568.10	0.00702	62.700	0.440	4.427	9.061	23.3
30	150	4.919	0.861	3.972	567.80	0.00700	62.900	0.440	4.412	9.027	23.2
31	155	4.921	0.861	3.946	567.70	0.00695	63.300	0.440	4.386	8.968	23.1
32	160	4.923	0.864	3.938	567.40	0.00694	63.400	0.440	4.378	8.950	23.1
33	165	4.921	0.861	3.925	567.30	0.00692	63.600	0.440	4.365	8.920	23.1
34	170	4.923	0.869	3.911	567.10	0.00690	63.800	0.440	4.351	8.889	23.1
35	175	4.925	0.888	3.911	567.10	0.00690	63.800	0.440	4.351	8.889	23.1
36	180	4.925	0.894	3.924	567.20	0.00692	63.600	0.440	4.364	8.918	23.1
37	185	4.925	0.856	3.925	567.40	0.00692	63.600	0.440	4.365	8.921	23.1
38	190	4.923	0.867	3.923	567.10	0.00692	63.600	0.440	4.363	8.917	23.0
39	195	4.923	0.867	3.915	566.80	0.00691	63.700	0.440	4.355	8.898	22.9
40	200	4.923	0.853	3.927	566.80	0.00693	63.500	0.440	4.367	8.926	23.0

Tabel D.4 Hasil perhitungan refrigeran Isobutan 100%

No	t	ρ	\dot{m}_{ud}	Q_{evap}	q_{re}	\dot{m}_{ref}	w_c	W_c	Q_c	COP	T_r
	menit	kg/m^3	kg/s	kW	kJ/kg	kg/s	kJ/kg	kW	kW		$^{\circ}C$
1	5	2.055	0.503	1.777	522.60	0.00340	90.60	0.308	2.085	5.768	26.0
2	10	2.056	0.497	1.749	521.90	0.00335	91.90	0.308	2.057	5.679	25.4
3	15	2.056	0.496	1.725	521.50	0.00331	93.10	0.308	2.033	5.602	25.0
4	20	1.974	0.472	1.700	521.50	0.00326	94.50	0.308	2.008	5.519	25.0
5	25	1.974	0.474	1.681	521.20	0.00323	95.50	0.308	1.989	5.458	24.8
6	30	1.974	0.437	1.670	521.20	0.00320	96.10	0.308	1.978	5.424	24.7
7	35	1.975	0.427	1.659	520.90	0.00319	96.70	0.308	1.967	5.387	24.6
8	40	1.974	0.433	1.659	521.00	0.00319	96.70	0.308	1.967	5.388	24.5
9	45	1.974	0.431	1.663	521.10	0.00319	96.50	0.308	1.971	5.400	24.5
10	50	1.974	0.432	1.660	521.10	0.00319	96.70	0.308	1.968	5.389	24.5
11	55	1.974	0.434	1.670	521.10	0.00320	96.10	0.308	1.978	5.422	24.4
12	60	1.975	0.448	1.662	520.80	0.00319	96.50	0.308	1.970	5.397	24.3
13	65	1.975	0.435	1.662	520.80	0.00319	96.50	0.308	1.970	5.397	24.2
14	70	1.975	0.485	1.662	520.80	0.00319	96.50	0.308	1.970	5.397	24.3
15	75	1.975	0.481	1.663	520.90	0.00319	96.50	0.308	1.971	5.398	24.3
16	80	1.975	0.491	1.658	520.60	0.00319	96.70	0.308	1.966	5.384	24.3
17	85	1.975	0.494	1.658	520.60	0.00319	96.70	0.308	1.966	5.384	24.2
18	90	1.975	0.498	1.658	520.50	0.00319	96.70	0.308	1.966	5.383	24.3
19	95	1.975	0.496	1.658	520.50	0.00319	96.70	0.308	1.966	5.383	24.1
20	100	1.976	0.481	1.653	520.50	0.00318	97.00	0.308	1.961	5.366	24.1
21	105	1.976	0.496	1.663	520.50	0.00320	96.40	0.308	1.971	5.399	24.1
22	110	1.976	0.501	1.656	520.50	0.00318	96.80	0.308	1.964	5.377	24.1
23	115	1.976	0.427	1.659	520.40	0.00319	96.60	0.308	1.967	5.387	24.1
24	120	1.976	0.436	1.663	520.50	0.00320	96.40	0.308	1.971	5.399	24.1
25	125	1.976	0.437	1.660	520.50	0.00319	96.60	0.308	1.968	5.388	24.1
26	130	1.976	0.429	1.660	520.50	0.00319	96.60	0.308	1.968	5.388	24.0
27	135	1.977	0.470	1.655	520.20	0.00318	96.80	0.308	1.963	5.374	24.1
28	140	1.977	0.451	1.656	520.30	0.00318	96.80	0.308	1.964	5.375	24.1
29	145	1.977	0.455	1.652	520.20	0.00318	97.00	0.308	1.960	5.363	24.1
30	150	1.977	0.476	1.659	520.20	0.00319	96.60	0.308	1.967	5.385	24.1
31	155	1.977	0.477	1.645	520.10	0.00316	97.40	0.308	1.953	5.340	24.1
32	160	1.977	0.466	1.645	520.10	0.00316	97.40	0.308	1.953	5.340	24.0
33	165	1.977	0.463	1.644	519.90	0.00316	97.40	0.308	1.952	5.338	24.0
34	170	1.977	0.454	1.640	519.80	0.00316	97.60	0.308	1.948	5.326	24.0
35	175	1.977	0.456	1.641	519.90	0.00316	97.60	0.308	1.949	5.327	24.0
36	180	1.977	0.464	1.640	519.80	0.00316	97.60	0.308	1.948	5.326	24.0
37	185	1.977	0.441	1.648	520.00	0.00317	97.20	0.308	1.956	5.350	24.0
38	190	1.977	0.429	1.644	520.00	0.00316	97.40	0.308	1.952	5.339	23.9
39	195	1.977	0.433	1.644	520.00	0.00316	97.40	0.308	1.952	5.339	23.9
40	200	1.977	0.502	1.644	520.00	0.00316	97.40	0.308	1.952	5.339	23.9

Tabel D.5 Hasil perhitungan campuran Propan 90% + Isobutan 10%

No	t	ρ	\dot{m}_{ud}	Q_{evap}	q_{re}	\dot{m}_{ref}	w_c	W_c	Q_c	COP	T_r
	menit	kg/m^3	kg/s	kW	kJ/kg	kg/s	kJ/kg	kW	kW		$^{\circ}C$
1	5	3.980	1.150	3.647	565.40	0.00645	64.80	0.418	4.065	8.725	27.3
2	10	3.975	1.170	3.666	565.70	0.00648	64.50	0.418	4.084	8.771	26.6
3	15	4.056	1.205	3.632	565.70	0.00642	65.10	0.418	4.050	8.690	26.3
4	20	4.054	1.215	3.596	566.00	0.00635	65.80	0.418	4.014	8.602	26.0
5	25	4.057	1.216	3.571	565.50	0.00631	66.20	0.418	3.989	8.542	25.9
6	30	4.057	1.238	3.571	565.50	0.00631	66.20	0.418	3.989	8.542	25.7
7	35	4.058	1.238	3.558	565.20	0.00630	66.40	0.418	3.976	8.512	25.6
8	40	4.056	1.237	3.550	565.60	0.00628	66.60	0.418	3.968	8.492	25.5
9	45	4.060	1.228	3.509	565.00	0.00621	67.30	0.418	3.927	8.395	25.5
10	50	4.058	1.216	3.525	565.00	0.00624	67.00	0.418	3.943	8.433	25.4
11	55	4.061	1.217	3.517	564.60	0.00623	67.10	0.418	3.935	8.414	25.3
12	60	4.060	1.206	3.519	564.90	0.00623	67.10	0.418	3.937	8.419	24.8
13	65	3.981	1.161	3.507	564.70	0.00621	67.30	0.418	3.925	8.391	24.6
14	70	3.981	1.129	3.496	564.60	0.00619	67.50	0.418	3.914	8.364	24.6
15	75	3.980	1.171	3.509	564.90	0.00621	67.30	0.418	3.927	8.394	24.4
16	80	3.980	1.139	3.520	565.00	0.00623	67.10	0.418	3.938	8.420	24.4
17	85	3.981	1.129	3.507	564.70	0.00621	67.30	0.418	3.925	8.391	24.5
18	90	3.983	1.086	3.507	564.60	0.00621	67.30	0.418	3.925	8.389	24.4
19	95	3.984	1.097	3.484	564.30	0.00617	67.70	0.418	3.902	8.335	24.3
20	100	3.984	1.108	3.484	564.30	0.00617	67.70	0.418	3.902	8.335	24.2
21	105	3.983	1.086	3.496	564.60	0.00619	67.50	0.418	3.914	8.364	24.2
22	110	3.983	1.075	3.485	564.50	0.00617	67.70	0.418	3.903	8.338	24.1
23	115	3.983	1.075	3.486	564.60	0.00617	67.70	0.418	3.904	8.340	24.1
24	120	3.983	1.073	3.485	564.50	0.00617	67.70	0.418	3.903	8.338	24.2
25	125	3.979	1.064	3.526	565.10	0.00624	67.00	0.418	3.944	8.434	24.1
26	130	3.983	1.062	3.485	564.50	0.00617	67.70	0.418	3.903	8.338	24.0
27	135	3.980	1.068	3.509	564.90	0.00621	67.30	0.418	3.927	8.394	24.0
28	140	3.980	1.072	3.509	564.90	0.00621	67.30	0.418	3.927	8.394	23.9
29	145	3.980	1.075	3.509	564.90	0.00621	67.30	0.418	3.927	8.394	23.9
30	150	3.980	1.068	3.508	564.80	0.00621	67.30	0.418	3.926	8.392	23.9
31	155	3.983	1.065	3.485	564.50	0.00617	67.70	0.418	3.903	8.338	23.8
32	160	3.981	1.062	3.485	564.50	0.00617	67.70	0.418	3.903	8.338	23.8
33	165	3.983	1.052	3.485	564.40	0.00617	67.70	0.418	3.903	8.337	23.7
34	170	3.980	1.055	3.519	564.90	0.00623	67.10	0.418	3.937	8.419	23.8
35	175	3.984	1.063	3.484	564.20	0.00617	67.70	0.418	3.902	8.334	23.8
36	180	3.983	1.052	3.517	564.50	0.00623	67.10	0.418	3.935	8.413	23.6
37	185	3.984	1.052	3.482	563.90	0.00617	67.70	0.418	3.900	8.329	23.7
38	190	3.981	1.032	3.528	564.70	0.00625	66.90	0.418	3.946	8.441	23.7
39	195	3.984	1.046	3.492	563.90	0.00619	67.50	0.418	3.910	8.354	23.8
40	200	3.983	1.022	3.504	564.10	0.00621	67.30	0.418	3.922	8.382	23.7

Tabel D.6 Hasil perhitungan refrigeran campuran Propan 80% + Isobutan 20%

No	t	ρ	\dot{m}_{ud}	Q_{evap}	q_{re}	\dot{m}_{ref}	w_c	W_c	Q_c	COP	T_r
	menit	kg/m^3	kg/s	kW	kJ/kg	kg/s	kJ/kg	kW	kW		$^{\circ}C$
1	5	4.132	1.194	3.380	559.50	0.00604	69.20	0.418	3.798	8.085	26.1
2	10	4.131	1.216	3.379	559.40	0.00604	69.20	0.418	3.797	8.084	25.1
3	15	4.130	1.227	3.365	559.50	0.00601	69.50	0.418	3.783	8.050	24.5
4	20	4.128	1.237	3.348	559.90	0.00598	69.90	0.418	3.766	8.010	24.0
5	25	4.130	1.238	3.318	559.60	0.00593	70.50	0.418	3.736	7.938	23.7
6	30	4.132	1.261	3.291	558.20	0.00590	70.90	0.418	3.709	7.873	23.4
7	35	4.134	1.261	3.277	559.00	0.00586	71.30	0.418	3.695	7.840	23.1
8	40	4.135	1.262	3.266	558.70	0.00585	71.50	0.418	3.684	7.814	23.0
9	45	4.137	1.251	3.259	558.30	0.00584	71.60	0.418	3.677	7.797	22.8
10	50	4.137	1.240	3.261	558.50	0.00584	71.60	0.418	3.679	7.800	22.7
11	55	4.137	1.240	3.251	558.50	0.00582	71.80	0.418	3.669	7.779	22.5
12	60	4.138	1.229	3.241	558.20	0.00581	72.00	0.418	3.659	7.753	22.4
13	65	4.142	1.208	3.229	557.80	0.00579	72.20	0.418	3.647	7.726	22.4
14	70	4.142	1.174	3.239	557.90	0.00581	72.00	0.418	3.657	7.749	22.3
15	75	4.139	1.218	3.241	558.30	0.00581	72.00	0.418	3.659	7.754	22.3
16	80	4.139	1.185	3.249	558.00	0.00582	71.80	0.418	3.667	7.772	22.2
17	85	4.139	1.173	3.240	558.10	0.00581	72.00	0.418	3.658	7.751	22.1
18	90	4.139	1.129	3.250	558.20	0.00582	71.80	0.418	3.668	7.774	22.1
19	95	4.139	1.140	3.241	558.20	0.00581	72.00	0.418	3.659	7.753	22.1
20	100	4.139	1.151	3.241	558.20	0.00581	72.00	0.418	3.659	7.753	22.2
21	105	4.143	1.130	3.233	557.70	0.00580	72.10	0.418	3.651	7.735	22.0
22	110	4.139	1.118	3.241	558.20	0.00581	72.00	0.418	3.659	7.753	22.0
23	115	4.141	1.118	3.231	558.00	0.00579	72.20	0.418	3.649	7.729	21.9
24	120	4.141	1.116	3.249	558.00	0.00582	71.80	0.418	3.667	7.772	21.9
25	125	4.143	1.108	3.233	557.70	0.00580	72.10	0.418	3.651	7.735	21.9
26	130	4.142	1.105	3.247	557.80	0.00582	71.80	0.418	3.665	7.769	21.9
27	135	4.142	1.112	3.238	557.70	0.00581	72.00	0.418	3.656	7.746	21.9
28	140	4.143	1.116	3.224	557.70	0.00578	72.30	0.418	3.642	7.714	21.8
29	145	4.141	1.118	3.240	558.00	0.00581	72.00	0.418	3.658	7.750	21.9
30	150	4.142	1.112	3.238	557.80	0.00581	72.00	0.418	3.656	7.747	21.8
31	155	4.143	1.108	3.233	557.70	0.00580	72.10	0.418	3.651	7.735	21.8
32	160	4.147	1.106	3.212	557.10	0.00577	72.50	0.418	3.630	7.684	21.8
33	165	4.145	1.094	3.233	557.60	0.00580	72.10	0.418	3.651	7.734	21.7
34	170	4.145	1.099	3.242	557.60	0.00581	71.90	0.418	3.660	7.755	21.8
35	175	4.143	1.105	3.252	557.80	0.00583	71.70	0.418	3.670	7.780	21.7
36	180	4.145	1.094	3.233	557.60	0.00580	72.10	0.418	3.651	7.734	21.7
37	185	4.143	1.094	3.243	557.80	0.00581	71.90	0.418	3.661	7.758	21.6
38	190	4.146	1.075	3.223	557.50	0.00578	72.30	0.418	3.641	7.711	21.6
39	195	4.147	1.088	3.222	557.30	0.00578	72.30	0.418	3.640	7.708	21.4
40	200	4.149	1.064	3.203	557.10	0.00575	72.70	0.418	3.621	7.663	21.4

Tabel D.7 Hasil perhitungan Propan 70% + Isobutan 30%

No	t	ρ	\dot{m}_{ud}	Q_{evap}	q_{re}	\dot{m}_{ref}	w_c	W_c	Q_c	COP	T_r
	menit	kg/m^3	kg/s	kW	kJ/kg	kg/s	kJ/kg	kW	kW		$^{\circ}C$
1	5	4.710	1.145	3.249	546.50	0.00595	70.300	0.418	3.667	7.774	27.2
2	10	4.793	1.149	3.235	545.70	0.00593	70.500	0.418	3.653	7.740	25.9
3	15	4.793	1.173	3.237	545.90	0.00593	70.500	0.418	3.655	7.743	25.8
4	20	4.795	1.207	3.226	545.70	0.00591	70.700	0.418	3.644	7.719	25.5
5	25	4.805	1.173	3.171	544.60	0.00582	71.800	0.418	3.589	7.585	25.2
6	30	4.803	1.144	3.181	544.90	0.00584	71.600	0.418	3.599	7.610	24.9
7	35	4.808	1.101	3.156	544.30	0.00580	72.100	0.418	3.574	7.549	25.0
8	40	4.346	0.976	2.999	540.90	0.00554	75.400	0.418	3.417	7.174	24.5
9	45	4.351	1.006	2.967	540.20	0.00549	76.100	0.418	3.385	7.099	24.5
10	50	4.354	0.990	2.949	539.80	0.00546	76.500	0.418	3.367	7.056	24.2
11	55	4.360	1.010	2.919	539.10	0.00541	77.200	0.418	3.337	6.983	24.3
12	60	4.362	1.102	2.910	538.90	0.00540	77.400	0.418	3.328	6.963	24.2
13	65	4.363	1.089	2.901	538.60	0.00539	77.600	0.418	3.319	6.941	24.3
14	70	4.363	1.077	2.902	538.70	0.00539	77.600	0.418	3.320	6.942	24.3
15	75	4.363	1.084	2.902	538.70	0.00539	77.600	0.418	3.320	6.942	24.1
16	80	4.363	1.086	2.901	538.60	0.00539	77.600	0.418	3.319	6.941	24.2
17	85	4.363	1.093	2.901	538.60	0.00539	77.600	0.418	3.319	6.941	24.0
18	90	4.365	1.084	2.893	538.40	0.00537	77.800	0.418	3.311	6.920	24.0
19	95	4.365	1.082	2.893	538.40	0.00537	77.800	0.418	3.311	6.920	23.9
20	100	4.365	1.063	2.885	538.40	0.00536	78.000	0.418	3.303	6.903	23.8
21	105	4.365	1.094	2.893	538.50	0.00537	77.800	0.418	3.311	6.922	23.8
22	110	4.365	1.087	2.893	538.50	0.00537	77.800	0.418	3.311	6.922	23.8
23	115	4.365	1.084	2.886	538.50	0.00536	78.000	0.418	3.304	6.904	23.6
24	120	4.366	1.040	2.876	538.10	0.00535	78.200	0.418	3.294	6.881	23.7
25	125	4.366	1.033	2.876	538.00	0.00535	78.200	0.418	3.294	6.880	23.8
26	130	4.366	1.028	2.876	538.10	0.00535	78.200	0.418	3.294	6.881	23.7
27	135	4.368	1.007	2.876	538.10	0.00535	78.200	0.418	3.294	6.881	23.4
28	140	4.368	1.002	2.876	538.10	0.00535	78.200	0.418	3.294	6.881	23.4
29	145	4.372	1.008	2.856	537.70	0.00531	78.700	0.418	3.274	6.832	23.4
30	150	4.207	0.966	2.857	537.90	0.00531	78.700	0.418	3.275	6.835	23.3
31	155	4.210	0.978	2.840	537.50	0.00528	79.100	0.418	3.258	6.795	23.3
32	160	4.210	0.973	2.833	537.50	0.00527	79.300	0.418	3.251	6.778	23.4
33	165	4.210	0.996	2.833	537.50	0.00527	79.300	0.418	3.251	6.778	23.2
34	170	4.210	0.980	2.833	537.50	0.00527	79.300	0.418	3.251	6.778	23.2
35	175	4.210	0.944	2.833	537.50	0.00527	79.300	0.418	3.251	6.778	23.2
36	180	4.212	0.928	2.818	537.30	0.00524	79.700	0.418	3.236	6.742	23.2
37	185	4.212	0.930	2.818	537.30	0.00524	79.700	0.418	3.236	6.742	23.1
38	190	4.212	0.928	2.818	537.30	0.00524	79.700	0.418	3.236	6.742	23.1
39	195	4.212	0.932	2.818	537.40	0.00524	79.700	0.418	3.236	6.743	23.1
40	200	4.212	0.973	2.818	537.30	0.00524	79.700	0.418	3.236	6.742	22.9

Tabel D.8 Hasil perhitungan Propan 50% + Isobutan 50%

No	t	P	\dot{m}_{ud}	Q_{evap}	q_{re}	\dot{m}_{ref}	w_c	W_c	Q_c	COP	T_r °C
	menit	kg/m ³	kg/s	kW	kJ/kg	kg/s	kJ/kg	kW	kW		
1	5	5.802	1.131	2.128	322.70	0.00659	73.40	0.484	2.612	4.396	27.6
2	10	5.804	1.172	2.121	322.50	0.00658	73.60	0.484	2.605	4.382	27.0
3	15	5.806	1.198	2.126	325.10	0.00654	74.00	0.484	2.610	4.393	26.9
4	20	5.728	1.182	2.116	324.80	0.00651	74.30	0.484	2.600	4.371	26.7
5	25	5.650	1.150	2.096	324.40	0.00646	74.90	0.484	2.580	4.331	26.6
6	30	5.650	1.162	2.098	324.70	0.00646	74.90	0.484	2.582	4.335	26.5
7	35	5.650	1.153	2.103	325.50	0.00646	74.90	0.484	2.587	4.346	26.4
8	40	5.650	1.129	2.084	323.40	0.00644	75.10	0.484	2.568	4.306	26.2
9	45	5.652	1.154	2.077	323.20	0.00643	75.30	0.484	2.561	4.292	26.2
10	50	5.652	1.175	2.081	323.70	0.00643	75.30	0.484	2.565	4.299	26.1
11	55	5.652	1.160	2.079	323.50	0.00643	75.30	0.484	2.563	4.296	26.1
12	60	5.579	1.121	2.047	322.30	0.00635	76.20	0.484	2.531	4.230	26.1
13	65	5.581	1.151	2.042	322.40	0.00634	76.40	0.484	2.526	4.220	26.0
14	70	5.583	1.128	2.039	322.30	0.00633	76.50	0.484	2.523	4.213	26.0
15	75	5.581	1.124	2.046	322.10	0.00635	76.20	0.484	2.530	4.227	26.0
16	80	5.583	1.131	2.037	322.00	0.00633	76.50	0.484	2.521	4.209	26.0
17	85	5.581	1.124	2.044	321.80	0.00635	76.20	0.484	2.528	4.223	25.9
18	90	5.583	1.179	2.034	321.50	0.00633	76.50	0.484	2.518	4.203	25.9
19	95	5.583	1.182	2.034	321.50	0.00633	76.50	0.484	2.518	4.203	26.0
20	100	5.583	1.191	2.039	321.50	0.00634	76.30	0.484	2.523	4.214	26.0
21	105	5.583	1.200	2.039	321.50	0.00634	76.30	0.484	2.523	4.214	25.9
22	110	5.583	1.197	2.039	321.50	0.00634	76.30	0.484	2.523	4.214	25.9
23	115	5.583	1.197	2.039	321.50	0.00634	76.30	0.484	2.523	4.214	25.9
24	120	5.503	1.180	2.029	321.50	0.00631	76.70	0.484	2.513	4.192	25.9
25	125	5.503	1.180	2.029	321.50	0.00631	76.70	0.484	2.513	4.192	25.9
26	130	5.503	1.180	2.029	321.50	0.00631	76.70	0.484	2.513	4.192	25.9
27	135	5.503	1.180	2.029	321.50	0.00631	76.70	0.484	2.513	4.192	25.9
28	140	5.503	1.180	2.029	321.50	0.00631	76.70	0.484	2.513	4.192	25.9
29	145	5.503	1.180	2.031	321.80	0.00631	76.70	0.484	2.515	4.196	25.9
30	150	5.503	1.180	2.031	321.80	0.00631	76.70	0.484	2.515	4.196	25.9
31	155	5.503	1.180	2.025	321.80	0.00629	76.90	0.484	2.509	4.185	25.9
32	160	5.503	1.180	2.025	321.80	0.00629	76.90	0.484	2.509	4.185	25.9
33	165	5.421	1.162	2.025	321.80	0.00629	76.90	0.484	2.509	4.185	25.9
34	170	5.421	1.162	2.027	322.10	0.00629	76.90	0.484	2.511	4.189	25.9
35	175	5.423	1.162	2.016	321.90	0.00626	77.30	0.484	2.500	4.164	25.9
36	180	5.423	1.162	2.016	321.90	0.00626	77.30	0.484	2.500	4.164	25.9
37	185	5.423	1.162	2.016	321.90	0.00626	77.30	0.484	2.500	4.164	25.9
38	190	5.423	1.162	2.016	321.90	0.00626	77.30	0.484	2.500	4.164	25.9
39	195	5.258	1.127	2.017	322.10	0.00626	77.30	0.484	2.501	4.167	25.9
40	200	5.258	1.127	2.017	322.10	0.00626	77.30	0.484	2.501	4.167	25.9

Lampiran

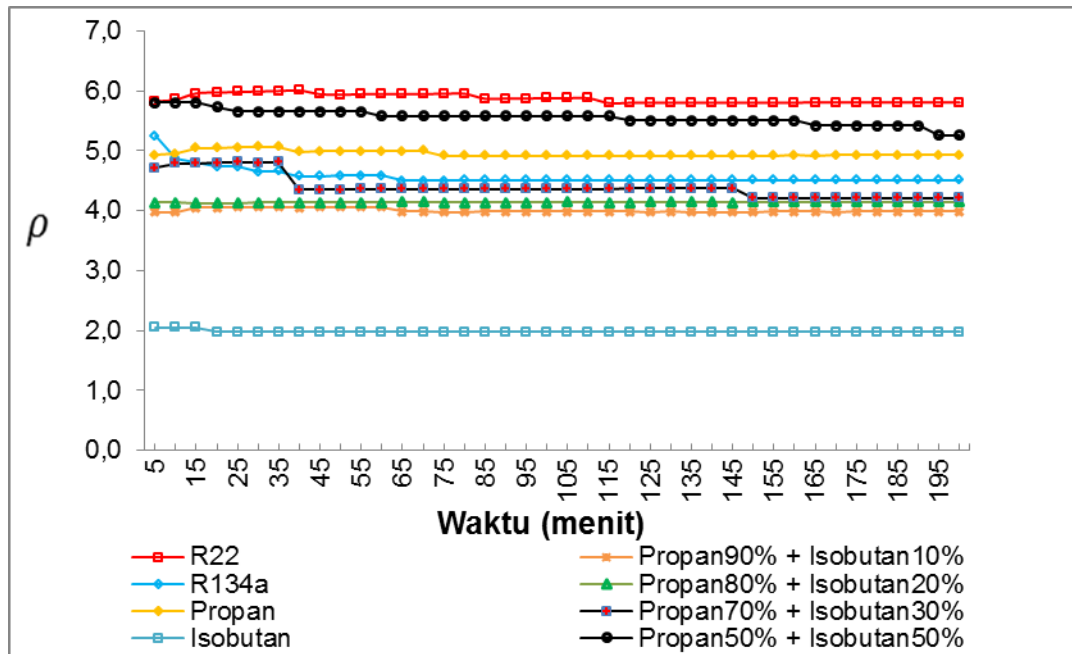

Gambar E.1 Waktu Vs Roh

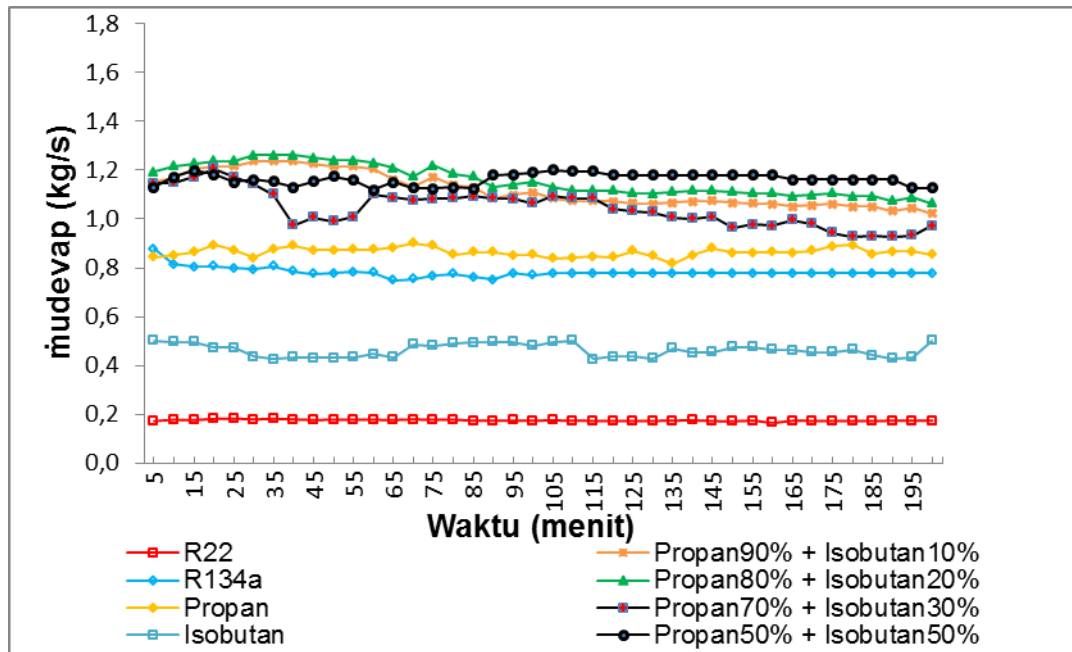

Gambar E.2 Waktu Vs Laju aliran massa udara evaporator

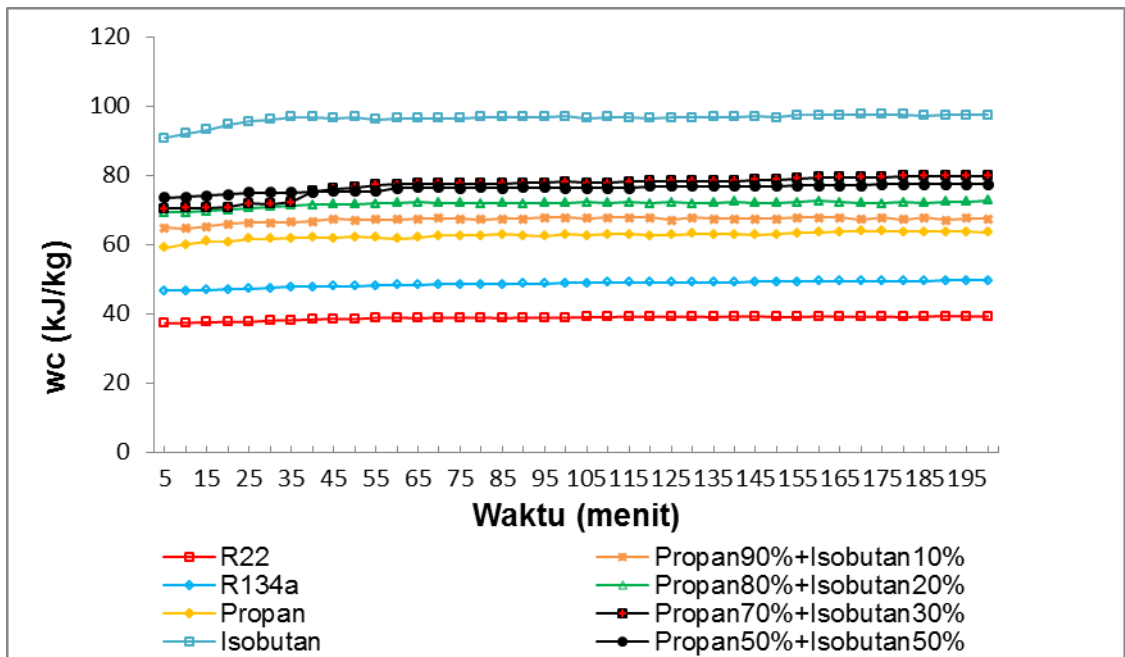

Gambar E.3 Waktu Vs Kerja kompresi

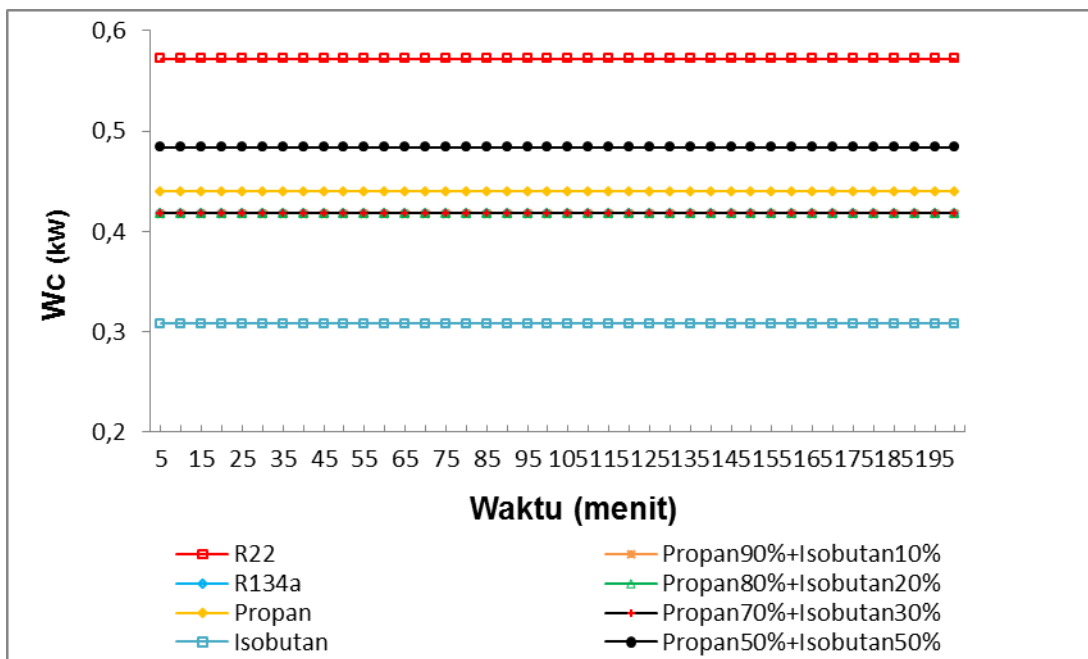

Gambar E.4 Waktu Vs Daya kompresi

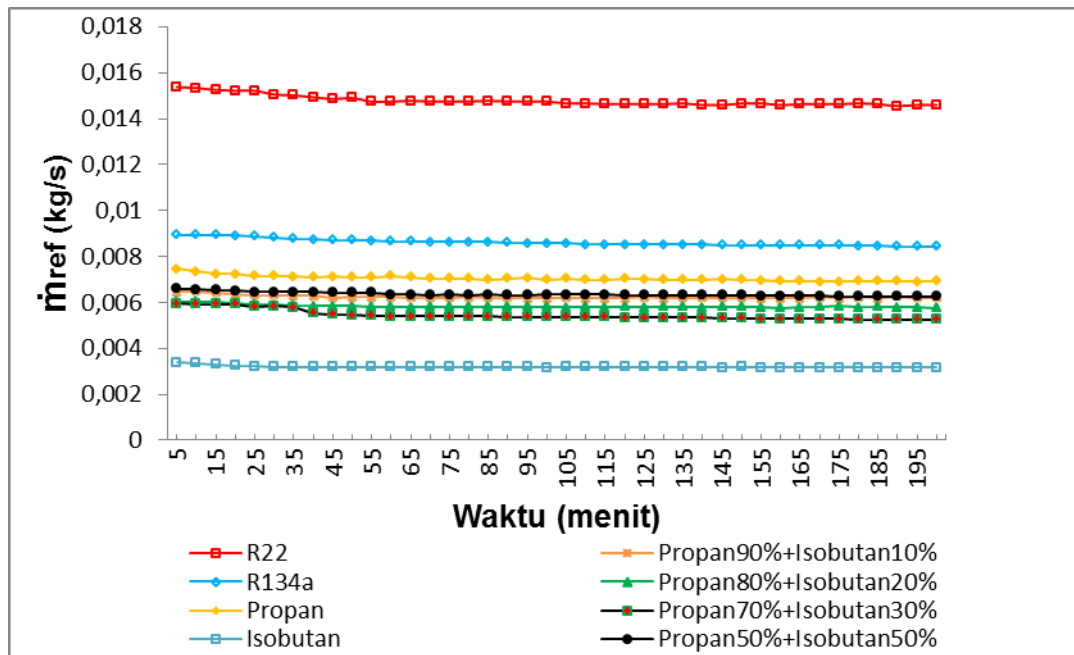

Gambar E.5 Waktu Vs Laju aliran massa refrigeran

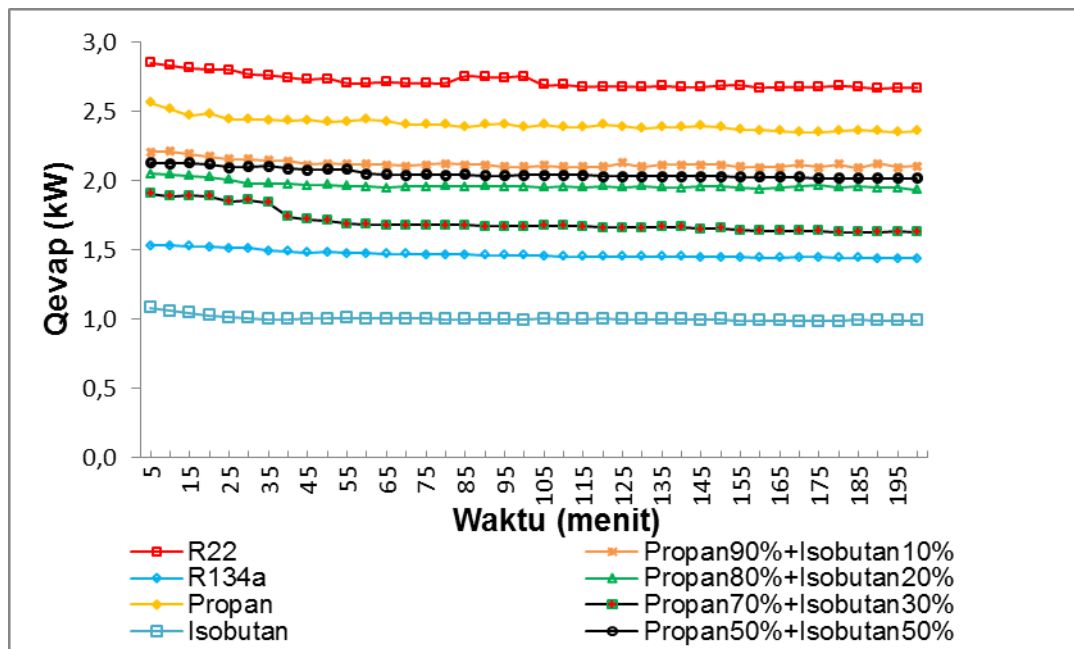

Gambar E.6 Waktu Vs Laju aliran kalor evaporator

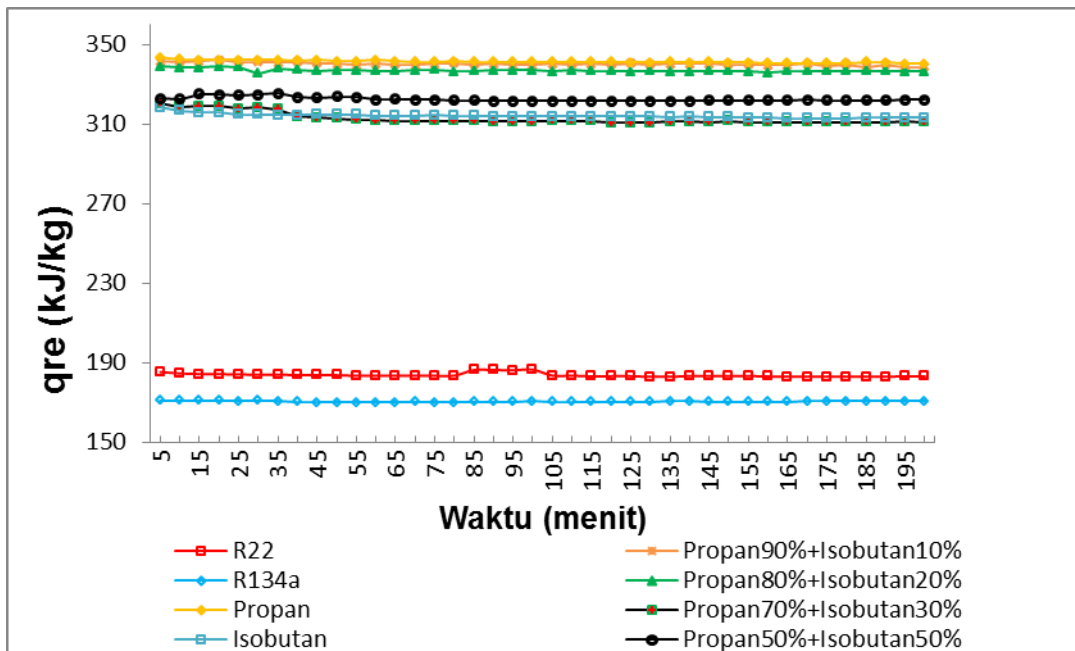

Gambar E.7 Waktu Vs Efek refrigerasi

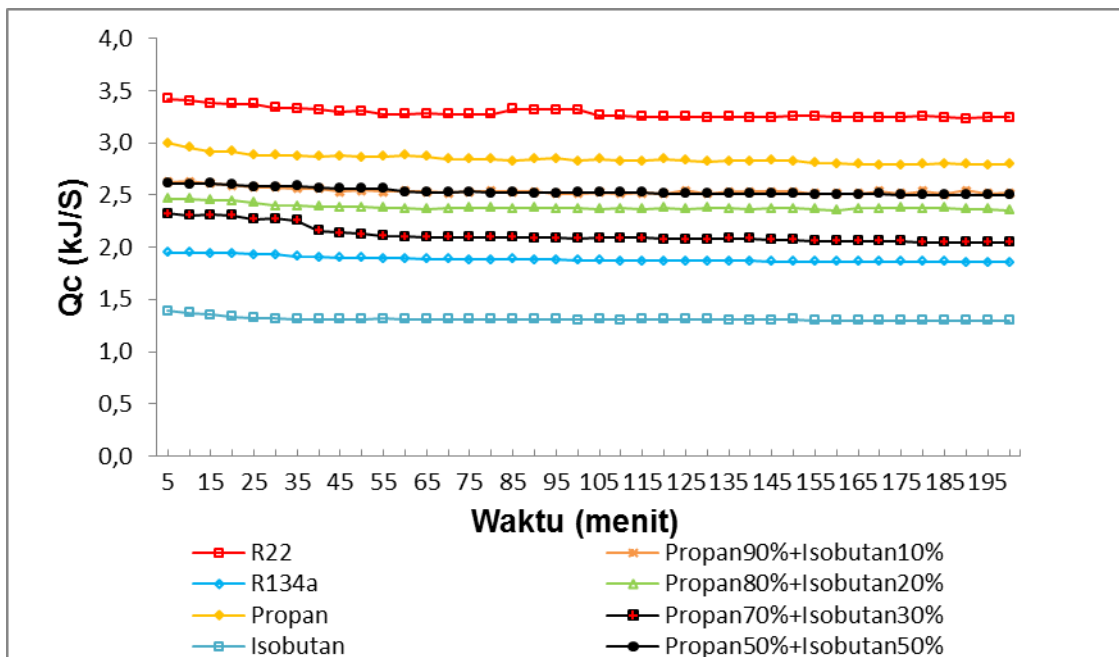

Gambar E.8 Waktu Vs Laju aliran kalor kondensor

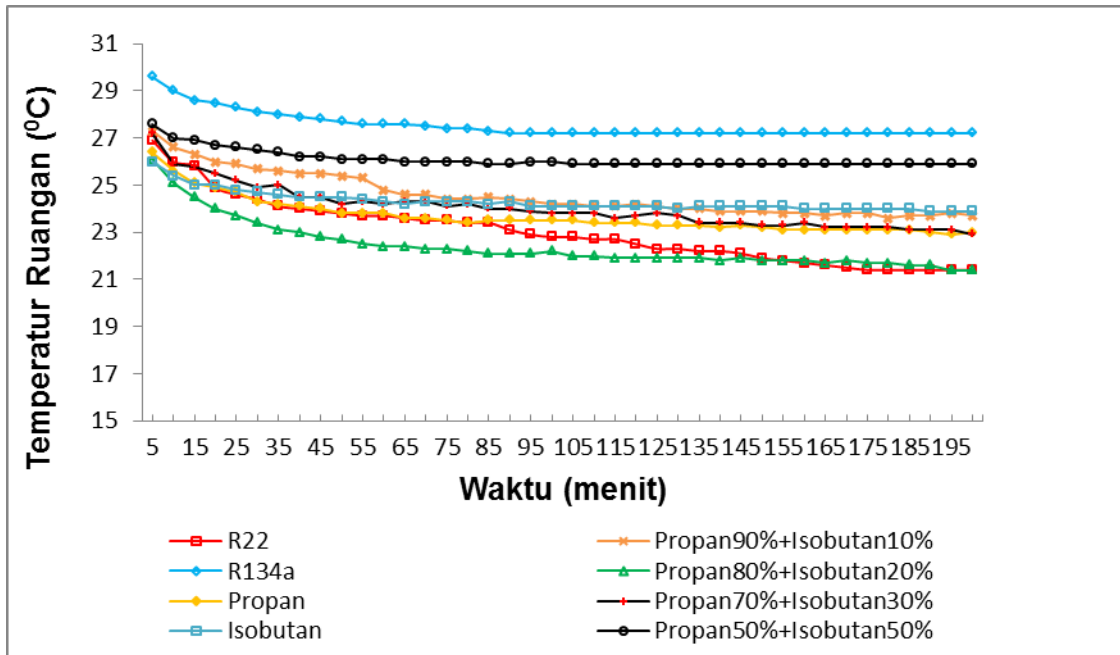

Gambar E.9 Waktu Vs Temperatur ruangan

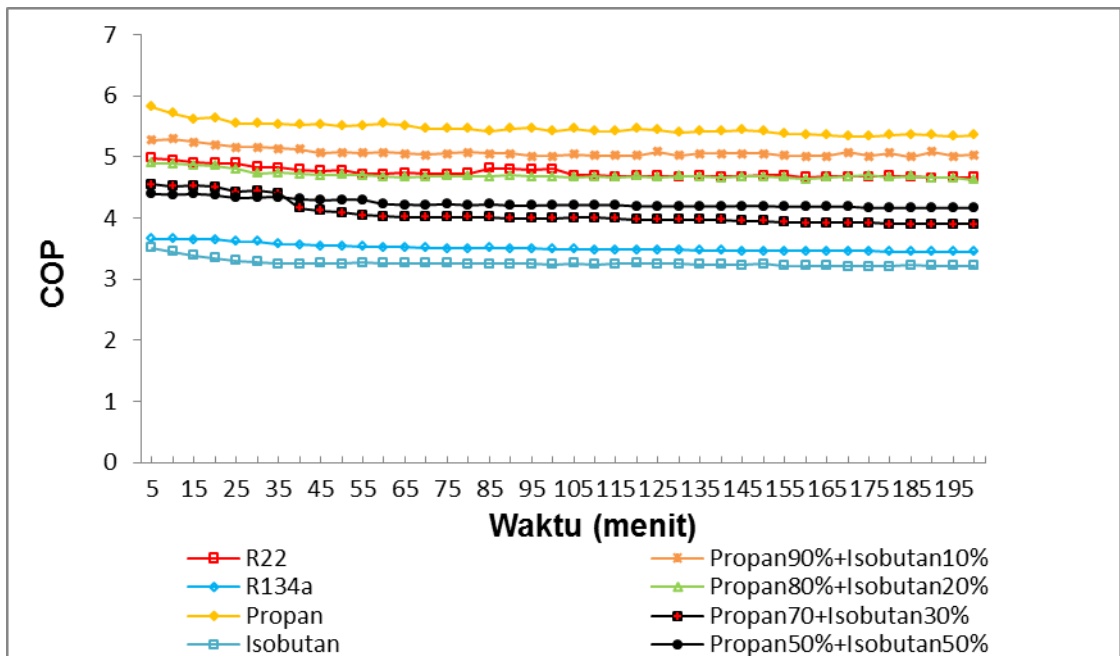

Gambar E.10 Waktu Vs COP