

DAFTAR PUSTAKA

1. Arizal, 2012. “Perancangan Sistem Informasi Akademik dan Mahasiswa”
<http://www.scribd.com/doc/82965600/Proposal-Arizal>. (akses 27 Februari 2012)
2. Munhidhotul Ummah, 2008. “Simulasi kestabilan sistem kontrol pada Permukaan cairan menggunakan metode kurva”. April 2008.
3. Gunterus, Frans, 1994. “Falsafah Dasar Sistem Pengendalian Proses”. Jakarta :Elex Media komputindo.
4. Dienan Firdaus, 2011. “Peranan *Wellsite Geologist* Dalam Eksplorasi Batubara”
http://batuanugrah.blogspot.com/2011_10_01_archive.html. (akses 29 November 2011)
5. Jogiyanto Hartono, 2004. “Sistem Pengendalian Umpan Balik”.
[http://elib.unikom.ac.id/files/disk1/443/jbptunikompp-gdl-prasenjawi-22134-6-\[9\]bab-i.pdf](http://elib.unikom.ac.id/files/disk1/443/jbptunikompp-gdl-prasenjawi-22134-6-[9]bab-i.pdf). (akses 24 Desember 2011)
6. Satya Kumara, 2007. “Digital Motion Control Hardware A Survey Paper”
<http://ml.scribd.com/doc/153387497/Makalah-Sistem-Kendali>. (akses 2 Juli 2009)
7. <http://insyaansori.blogspot.com/2013/02/sistem-kontrol-loop-terbuka-dan-sistem.html>.
(akses 22 Februari 2013)
8. <http://eviandrianimosy.blogspot.com/2010/05/pengertian-sistem-kendali.html>. (akses 30 Mei 2010)
9. Lincoln F. Lautenschlager Maro a “ *Process technology in the petroleum refining industry*currentsituation and future trends*” *Computers and Chemical Engineering* 27 (2003) 1303_1305
10. Anup, K Swain; Hemlata, Patra; G K Roy; 2011. “Mecahanical Operations”, New Dehli : 2011.
11. CEMA (Conveyor Equipment Manufactures Association), *Belt Conveyor For Bulk Materials, Second Edition*, CBI Publishing Company, Inc, Boston, Massachusetts: 2006.
12. Kurimoto, *Crushing And Grinding*, Kurimoto LTD, Minato-ku, Tokyo, Japan
13. Awang Suwandhi, 2005 “Rencana Pengolahan Batubara”
<http://www.scribd.com/doc/42666928/Rencana-Pengolahan-decrypted>.
(akses 15 November 2010)
14. <http://jasminecreatif.blogspot.com/2011/05/faktor-faktor-yang-mempengaruhi.html>
(akses 8 Mei 2011)
15. Munhidhotul Ummah, 2008. “Simulasi Kestabilan Sistem Kontrol Pada

- Permukaan Cairan Menggunakan Metode Kurva Reaksi Pada Metode Ziegler-Nichols Berbasis Bahasa Delphi”, Malang.
16. Ya'umar dan Totok R. Biyanto, 2006 “Optimasi Perawatan *Stone Crusher* Menggunakan *Reliabilitycentered Maintenance (RCM)*”, Surabaya.
 17. *Scribd, internet, <http://www.scribd.com/doc/42666928/Rencana-Pengolahan-decrypted>* (akses :15 November 2010).
 18. <http://bahangaliantambang.blogspot.com/2011/12/jenis-jenis-batubara.html>. (15 Desember 2011)
 19. *Scribd, internet, <http://www.scribd.com/doc/97103505/genesa-cbm>*. (4 Juni 2012)
 20. JCOAL, *Kuri-n ni Riyou Sareru Sekitan*, Japan Coal Energy Center, 2005.
 21. Feri Yuliansyah Ofanda, 2012. “Gambut Untuk Listrik”. Palembang
http://fyofa.blogspot.com/2012_08_01_archive.html, (akses 17 Agustus 2012)
 22. Prandika Nur Pratama, 2012 “Penambangan dan Pengolahan Batubara”, Kalsel.
http://batubara-anugrah.blogspot.com/2012_05_01_archive.html, (24 Mei 2012)
 23. *Report of the Result of the International Coal Liquefaction Cooperation Project*, 2005.
 24. <http://scientificindonesia.wordpress.com/proses-pengolahan-batubara/>
 25. Orchin, M., Reggel L. *Aromatic Cyclodehydrogenation*, J. Am. Chem. Soc., 69, 2005, 505-509.
 26. Orchin, M., et al, *Aromatic Cyclodehydrogenation*, BUREAU of Mines Tech. Paper 708, 1948, 40pp.
 27. Shunichi Yanai and Takuo Shigehisa: CCT Journal, vol.7, p 29, 2005.

Lampiran 1

Gambar grafik dalam keadaan normal

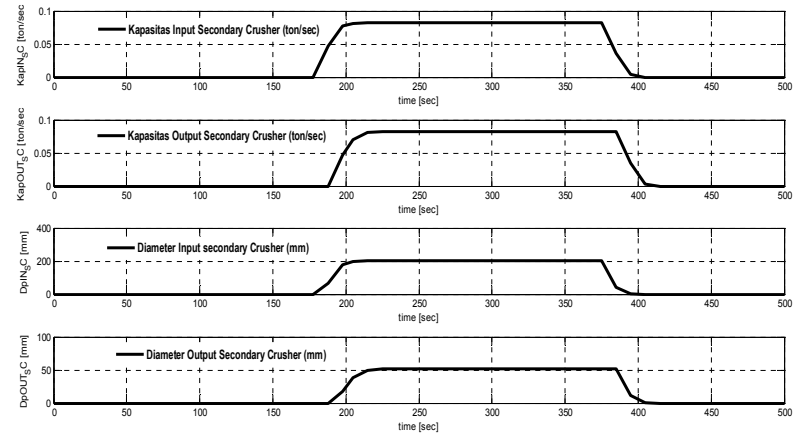
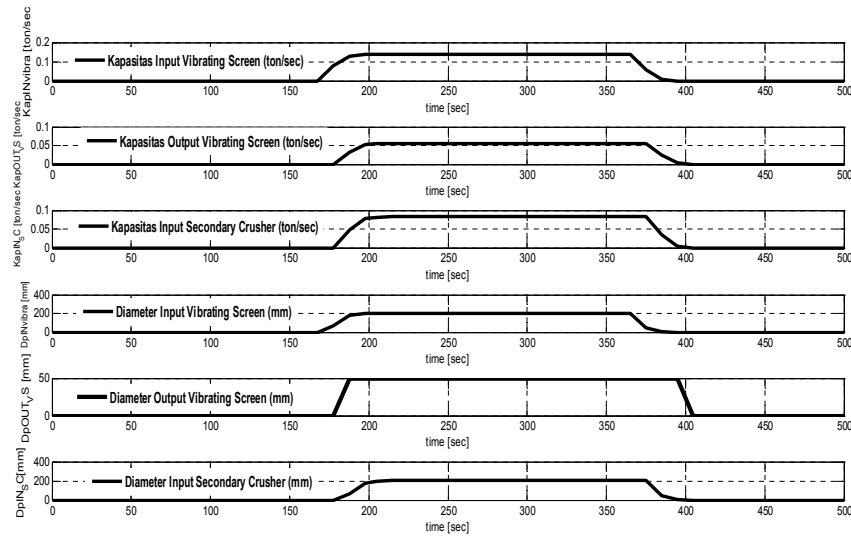
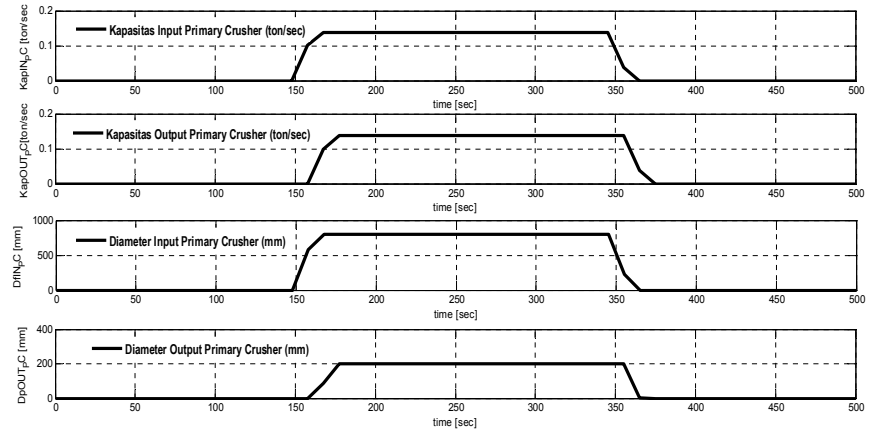
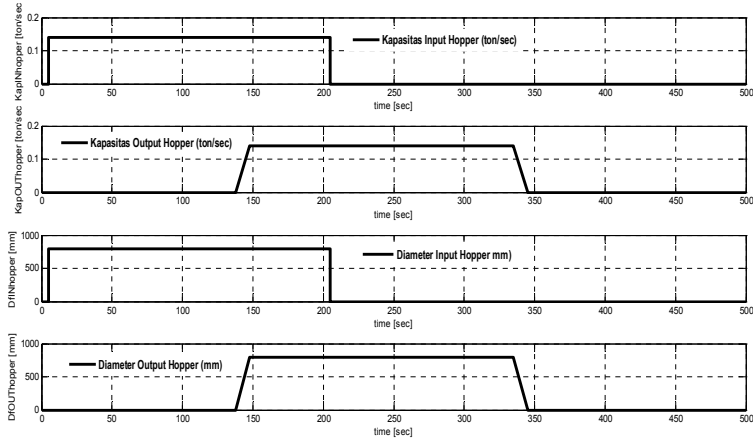

Lampiran 2

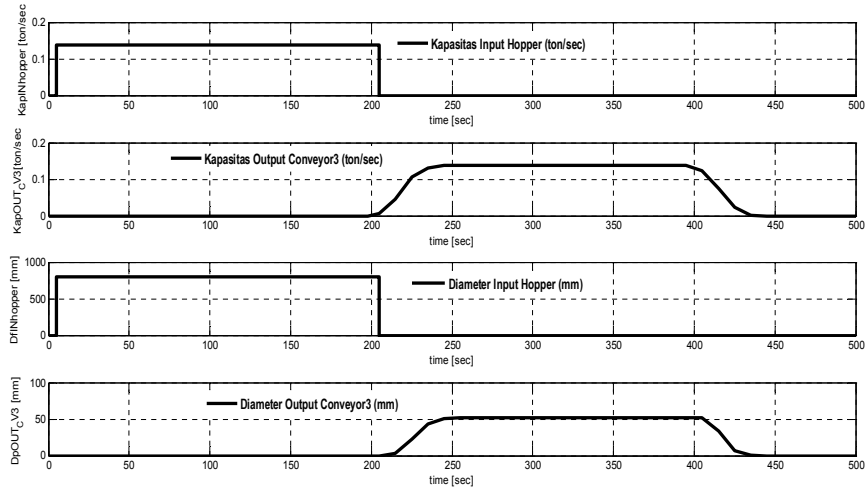

Lampiran 3

Gambar grafik gangguan diameter

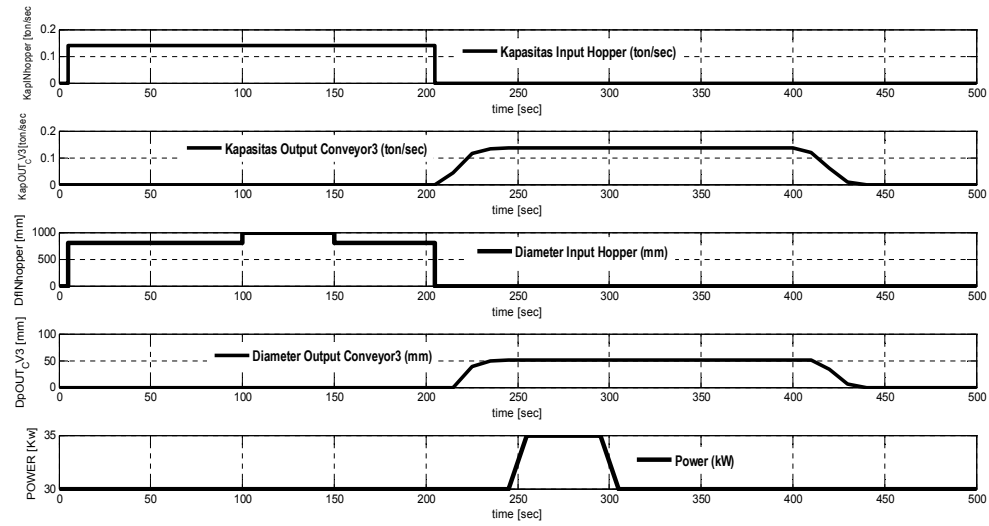
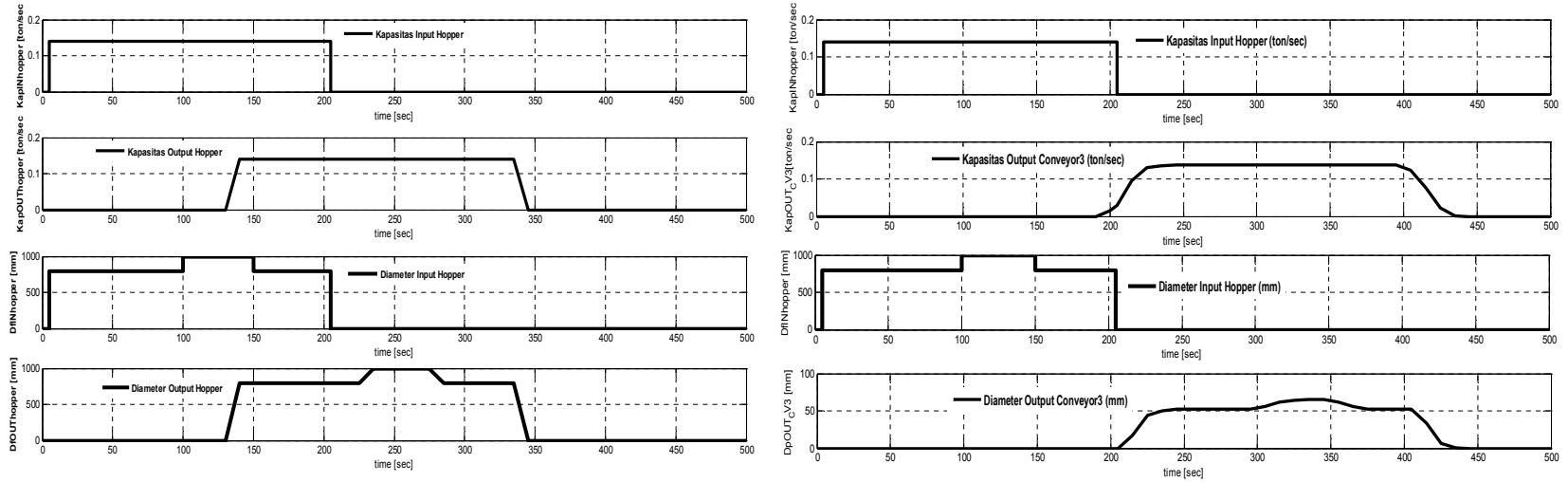

Lampiran 4

Gambar grafik gangguan tumpukan

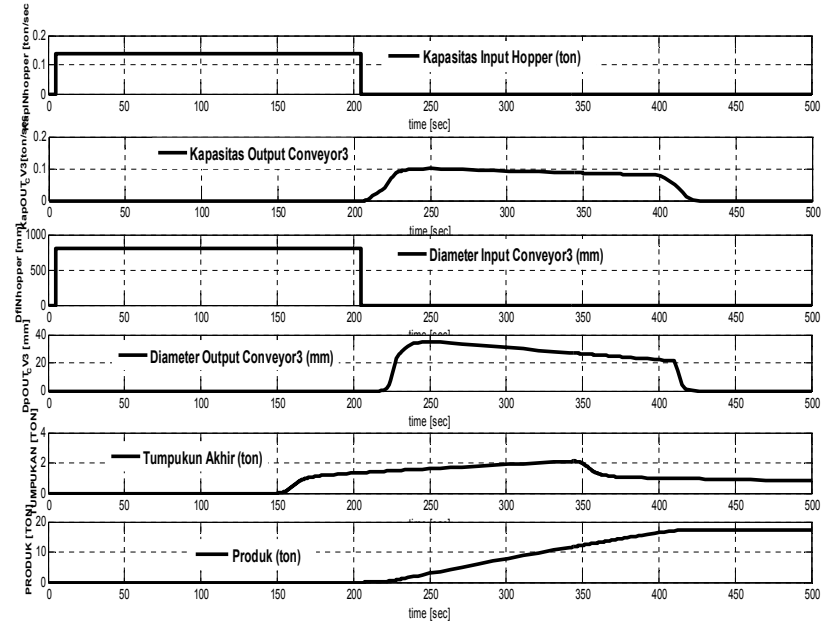
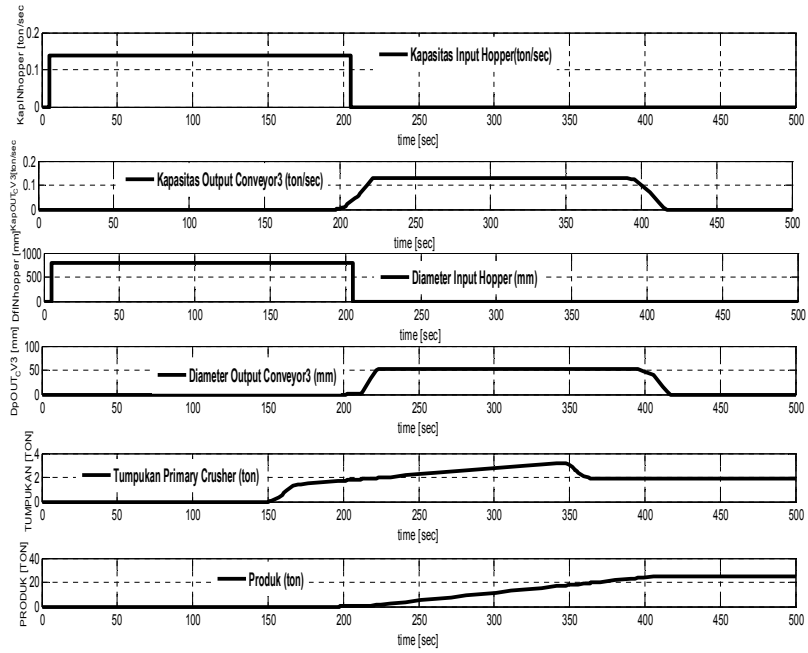

Lampiran 5

Gambar blok diagram kondisi normal

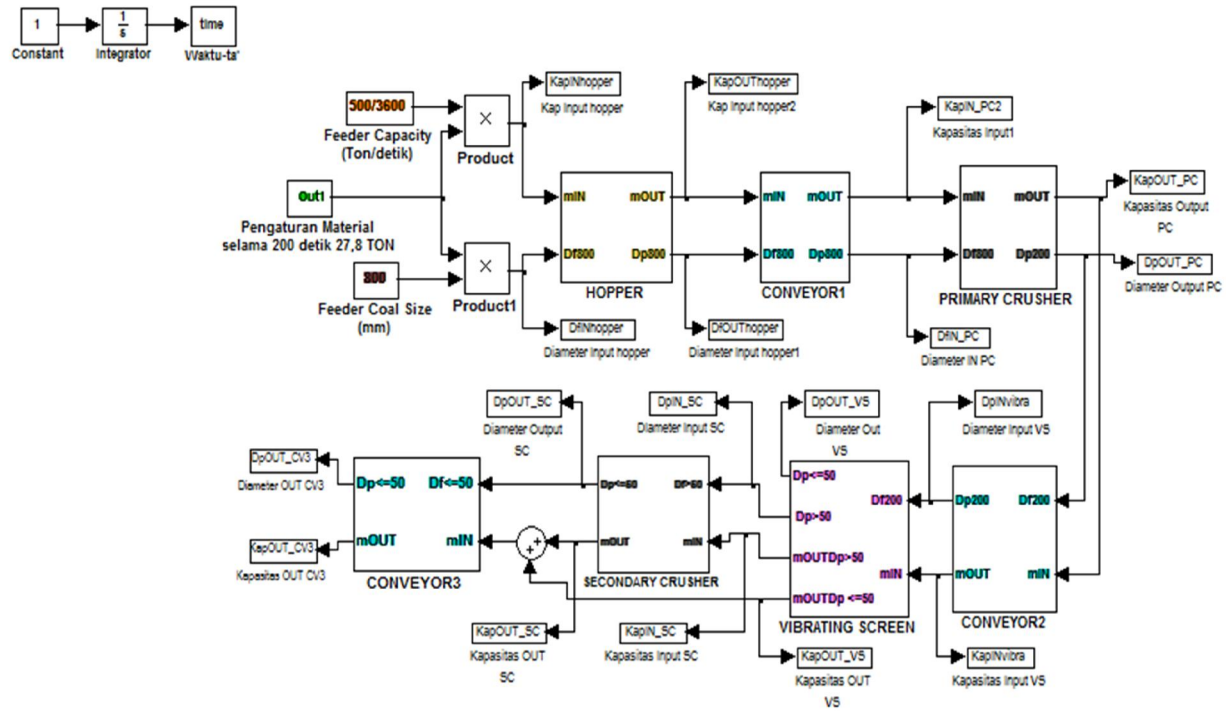

LAMPIRAN