

## DAFTAR PUSTAKA

- Arwini, 2018. "*Studi Pengaruh Perubahan Bentuk Lambung Kapal Feri Terhadap Kecepatan Kapal*". Jurusan Teknik Perkapalan, Fakultas Teknik, Universitas Hasanuddin. Makassar.
- Budiarto, Galih (2011). *Testing Position Step Hull at the National Corvette Battleship the Size of 90 meters With CFD Analysis Approach*. Department Of Marine Engineering, Ocean Engineering Faculty, ITS, Surabaya
- Hakim, Pradipta Rahman & IKAP Utama, 2018." *Analisa Hambatan dan Pitching Moment Equilibrium Pada Kapal Planing Jenis Monohull with Transverse Step Pada Perairan Calm Water*". Teknik Perkapalan, Fakultas Teknologi Kelautan, Institut Teknologi Sepuluh Nopember. Surabaya.
- Harvald, A, 1988. "*Tahanan dan Propulsi Kapal.*" Airlangga University Press, Surabaya.
- Loni, Afshin, Parvis Ghadimi, Hashem Nowruzi, & Abbas Dashtimanesh, 2013. "*Developing a computer program for mathematical investigation of stepped planing hull characteristics*". Department of Marine Technology, Amirkabir University of Technology.
- Marco, Agostino De, dkk. 2017." *Experimental and numerical hydrodynamic analysis of a stepped planing hull*". Department of Industrial Engineering, University of Napoli Federico II. Italy.
- Matveev, Konstantin I, & Ghazi S Bari. 2015. "*Effect of deadrise angles on hydrodynamic performance of a stepped hull*". School of Mechanical and Materials Engineering, Washington State University. Pullman. USA.
- Muhady, Trias.2020." *Studi Prediksi Tahanan Semi Planing Hull Bentuk Stepped Dengan Aplikasi Autodesk Cfd*". Departemen Teknik Perkapalan, Fakultas Teknik, Universitas Hasanuddin. Makassar.

- Muthahhar, Muhammad Syaufiy, 2020. “*Studi Tahanan Kapal Cepat Berbentuk Lambung Deadrise Angle Dan Variasi Bentuk Lambung Bertangga Menggunakan Aplikasi Software*”. Departemen Teknik Perkapalan, Fakultas Teknik, Universitas Hasanuddin. Makassar.
- Molland, A. F., Turnock, S. R., & Hudson, D. A. (2017). “*Ship Resistance And Propulsion. Cambridge University Press*”.
- Pranatal, Erifive. 2020. “*Pengaruh Sudut Deadrise Terhadap Tahanan Planning Hull*”. Institut Teknologi Adhi Tama Surabaya. Surabaya.
- Purwanto, Dedi Budi, Ridho Hantoro, Ketut Aria Pria Utama, .” *Studi Prediksi Tahanan Semi Planing Hull Bentuk Stepped Dengan Aplikasi Autodesk Cfd*”. Departemen Teknik Perkapalan, Fakultas Teknik, Universitas Hasanuddin. Makassar.
- Rosmani, Muhammad, A, H., & Algan, M. (2013). “*Prediksi Tahanan Kapal Cepat Dolpin Dengan Metode Eksperimen*”. Jurnal Teknik Universitas Hasanuddin: Makassar.
- Sandiary, dkk (2019). “*Besarnya Hambatan Kapal Dengan Sudut Stephull Diatas 180<sup>0</sup> Pada Kapal Cepat Planning Hull*”. Program Studi Teknik Perkapalan, Universitas Hang Tuah.
- Savitsky, D., & others. (1964). “*Hydrodynamic design of planning hulls*”. Marine Technology and SNAME News.

## **LAMPIRAN**

**Lampiran 1. Tabel Offset Lines Plan Kapal Penumpang cepat SS 44**

W L	Dra ft	Offset Table										
		0	1	2	3	4	5	6	7	8	9	10
B	0	0.3	0.4	0.4	0.5	0.5	0.5	0.5	0.5	0.4	0.2	-
1	0.0	0.5	0.7	0.7	0.8	0.8	0.8	0.8	0.8	0.7	0.4	-
2	0.1	0.7	0.9	1.1	1.1	1.2	1.2	1.2	1.1	0.9	0.5	-
3	0.2	1.0	1.2	1.4	1.5	1.5	1.5	1.5	1.5	1.2	0.7	-
4	0.3	1.2	1.4	1.7	1.8	1.9	1.9	1.9	1.8	1.4	0.8	-
5	0.3	1.4	1.7	1.9	1.9	1.9	1.9	1.9	1.9	1.7	1.0	-
6	0.4	1.6	1.9	1.9	1.9	1.9	1.9	1.9	1.9	1.8	1.2	-
9	0.6	1.8	1.9	2.0	2.0	2.0	2.0	2.0	2.0	1.8	1.5	0.2
12	0.9	1.8	1.9	2.0	2.0	2.0	2.0	2.0	2.0	1.9	1.6	0.4
15	1.1	1.9	2.0	2.1	2.1	2.1	2.1	2.1	2.0	2.0	1.6	0.6
18	1.3	1.9	2.0	2.1	2.1	2.1	2.1	2.1	2.1	2.0	1.7	0.7
21	1.5	2.0	2.1	2.1	2.2	2.2	2.2	2.2	2.1	2.1	1.8	0.9
24	1.8	2.0	2.1	2.2	2.2	2.2	2.2	2.2	2.2	2.0	1.9	1.0
	Dec	2.0	2.1	2.2	2.2	2.2	2.2	2.2	2.2	2.2	2.0	1.3

## Lampiran 2. Statistik jumlah elemen mesh

### 2.1 Statistik mesh model kapal satu stepped V

Statistik *mesh* model kapal satu *stepped V* dengan kecepatan 2.123 m/s dengan trim 2.190°

No	Nama	Jumlah	
		Nodes	Element
1	fluid	143980	522692
2	solide	231711	1302247
Total		375691	1824939

Statistik *mesh* model kapal satu *stepped V* dengan kecepatan 2.294 m/s dengan trim 2.885°

No	Nama	Jumlah	
		Nodes	Element
1	fluid	116780	425012
2	solide	179886	1012333
total		296666	1437345

Statistik *mesh* model kapal satu *stepped V* dengan kecepatan 2.439 m/s dengan trim 3.182°

No	Nama	Jumlah	
		Nodes	Element
1	fluid	95989	357382
2	solide	161598	895361
total		257587	1252743

Statistik *mesh* model kapal satu *stepped V* dengan kecepatan 2.653 m/s dengan trim 3.551°

No	Nama	Jumlah	
		Nodes	Element
1	fluid	91050	339314
2	solide	155781	854680
total		246831	1193994

Statistik *mesh* model kapal satu *stepped* V dengan kecepatan 2.959 m/s dengan trim 3.886°

no	nama	jumlah	
		nodes	element
1	fluid	87259	325643
2	solide	172535	935866
total		257715	1261509

Statistik *mesh* model kapal satu *stepped* V dengan kecepatan 3.279 m/s dengan trim 4.127°

No	Nama	Jumlah	
		Nodes	Element
1	fluid	133644	487327
2	solide	246127	1407209
total		379771	1894536

Statistik *mesh* model kapal satu *stepped* V dengan kecepatan 3.650m/s dengan trim 4.371°

No	Nama	Jumlah	
		Nodes	Element
1	fluid	114316	419962
2	solide	194559	1099646
total		308875	1519608

Statistik *mesh* model kapal satu *stepped* V dengan kecepatan 4.167 m/s dengan trim 4.634°

No	Nama	Jumlah	
		Nodes	Element
1	fluid	111563	410576
2	solide	209750	1188099
total		321313	1598675

## 2.2 Statistik mesh model kapal dua stepped V

Statistik *mesh* model kapal dua *stepped V* dengan kecepatan 2.169 m/s dengan trim 2.241°

No	Nama	Jumlah	
		Nodes	Element
1	fluid	84707	318413
2	solide	141188	766421
total		225895	766421

Statistik *mesh* model kapal dua *stepped V* dengan kecepatan 2.294 m/s dengan trim 2.610°

No	Nama	Jumlah	
		Nodes	Element
1	fluid	84739	313918
2	solide	137857	750728
total		222596	1064646

Statistik *mesh* model kapal dua *stepped V* dengan kecepatan 2.532 m/s dengan trim 3.026°

No	Nama	Jumlah	
		Nodes	Element
1	fluid	90796	337004
2	solide	143832	786855
total		234628	1123859

Statistik *mesh* model kapal dua *stepped V* dengan kecepatan 2.762 m/s dengan trim 3.364°

No	Nama	Jumlah	
		Nodes	Element
1	fluid	96976	361200
2	solide	160614	889951
total		257590	1251151

Statistik *mesh* model kapal dua *stepped V* dengan kecepatan 2.959 m/s dengan trim 3.659°

No	Nama	Jumlah	
		Nodes	Element
1	fluid	98404	366918
2	solide	185583	1011706
total		283987	1378624

Statistik *mesh* model kapal dua *stepped V* dengan kecepatan 3.356 m/s dengan trim 3.996°

No	Nama	Jumlah	
		Nodes	Element
1	fluid	95261	353518
2	solide	152665	849138
total		247926	1202656

Statistik *mesh* model kapal dua *stepped V* dengan kecepatan 3.546/s dengan trim 4.283°

No	Nama	Jumlah	
		Nodes	Element
1	fluid	92804	344899
2	solide	161358	890261
total		254162	1235160

Statistik *mesh* model kapal dua *stepped V* dengan kecepatan 3.65 m/s dengan trim 4.396°

No	Nama	Jumlah	
		Nodes	Element
1	fluid	93157	349586
2	solide	163120	901413
total		256277	1250999



**a. Statistik mesh model kapal tiga stepped V**

Statistik *mesh* model kapal tiga *stepped* V dengan kecepatan 2.132 m/s dengan trim 2.194°

No	Nama	Jumlah	
		Nodes	Element
1	fluid	74707	288414
2	solide	122472	653710
total		197179	942124

Statistik *mesh* model kapal tiga *stepped* V dengan kecepatan 2.247 m/s dengan trim 2.277°

No	Nama	Jumlah	
		Nodes	Element
1	fluid	78311	300989
2	solide	125264	671874
total		203575	972863

Statistik *mesh* model kapal tiga *stepped* V dengan kecepatan 2.632 m/s dengan trim 2.471°

No	Nama	Jumlah	
		Nodes	Element
1	fluid	96337	362372
2	solide	144206	791011
total		240543	1153383

Statistik *mesh* model kapal tiga *stepped* U dengan kecepatan 2.882 m/s dengan trim 2.693°

No	Nama	Jumlah	
		Nodes	Element
1	fluid	101061	376563
2	solide	149635	824128
total		250696	1200691

Statistik *mesh* model kapal tiga *stepped V* dengan kecepatan 3.003 m/s dengan trim 2.849°

No	Nama	Jumlah	
		Nodes	Element
1	fluid	98510	363879
2	solide	150831	836577
total		249341	1200456

Statistik *mesh* model kapal tiga *stepped V* dengan kecepatan 3.367 m/s dengan trim 3.229°

No	Nama	Jumlah	
		Nodes	Element
1	fluid	98970	365551
2	solide	149998	831145
total		248968	1196696

Statistik *mesh* model kapal tiga *stepped V* dengan kecepatan 3.546 m/s dengan trim 3.714°

No	Nama	Jumlah	
		Nodes	Element
1	fluid	82078	306733
2	solide	136276	754154
total		218354	1060887

Statistik *mesh* model kapal tiga *stepped V* dengan kecepatan 3.623 m/s dengan trim 4.042°

No	Nama	Jumlah	
		Nodes	Element
1	fluid	88540	333101
2	solide	170790	927360
total		259330	1260461

### Lampiran 3. Gambar visualisasi velocity magnitude

#### 3.1 Gambar visualisasi velocity magnitude pada model kapal satu stepped V

- Kecepatan 2.29 m/s dengan trim 2.88°

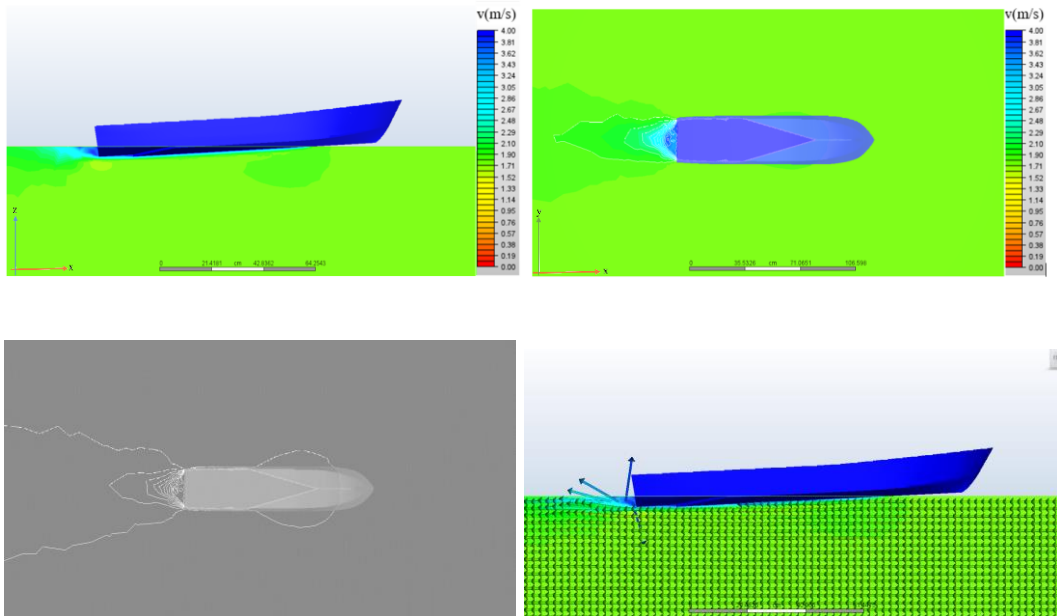

- Kecepatan 2.43 m/s dengan trim 3.18°

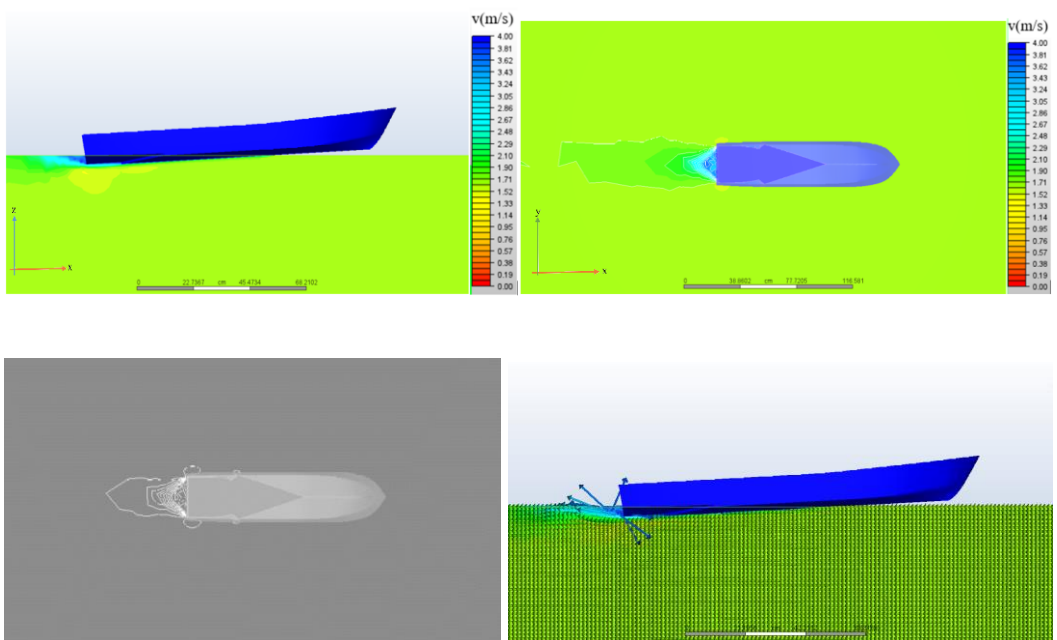

- Kecepatan 2.65 m/s dengan trim 3.55°

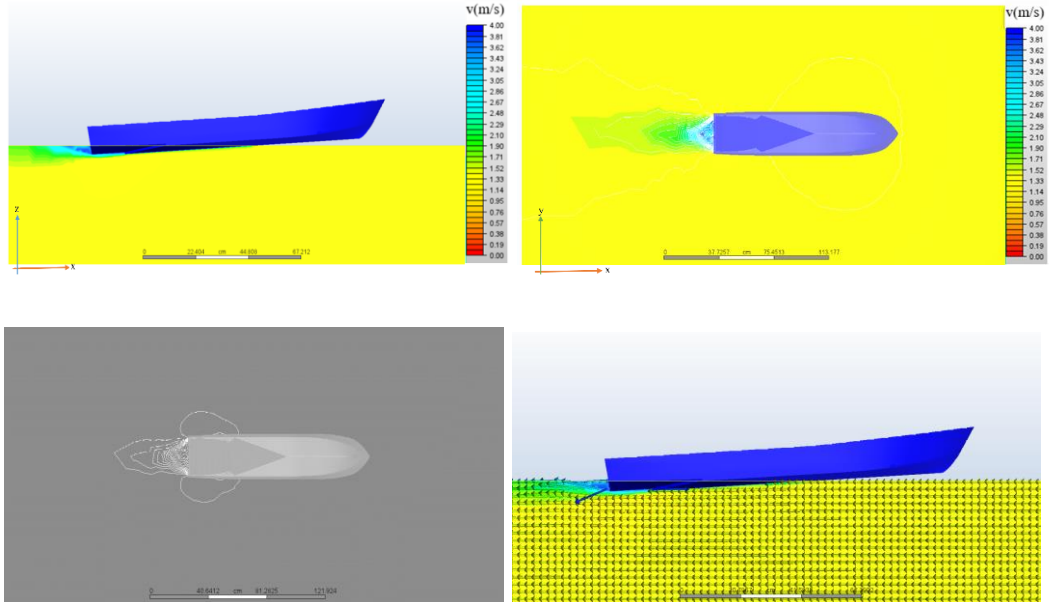

- Kecepatan 3.27 m/s dengan trim 4.13°

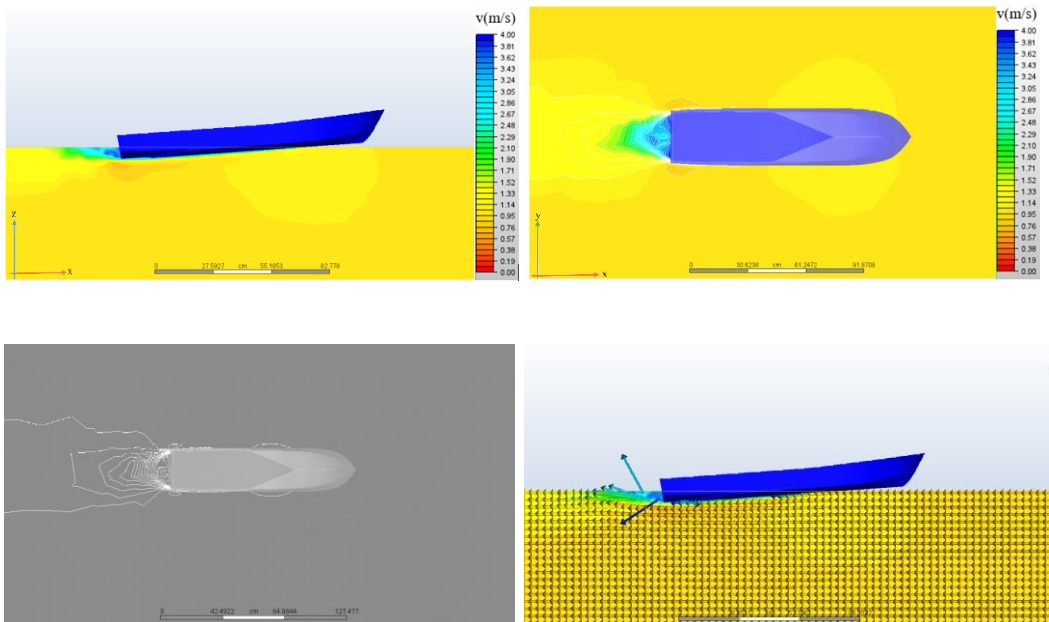

- Kecepatan 3.65 m/s dengan trim 4.37°

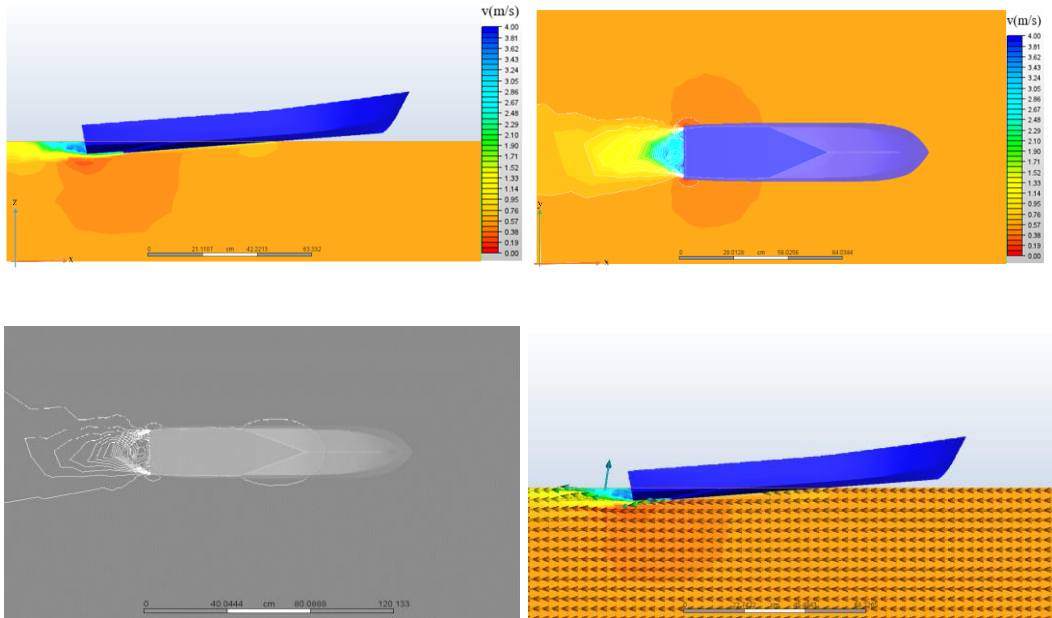

**Gambar visualisasi velocity magnitude pada model kapal dua stepped V**

- Kecepatan 2.294 m/s dengan trim 2.61°

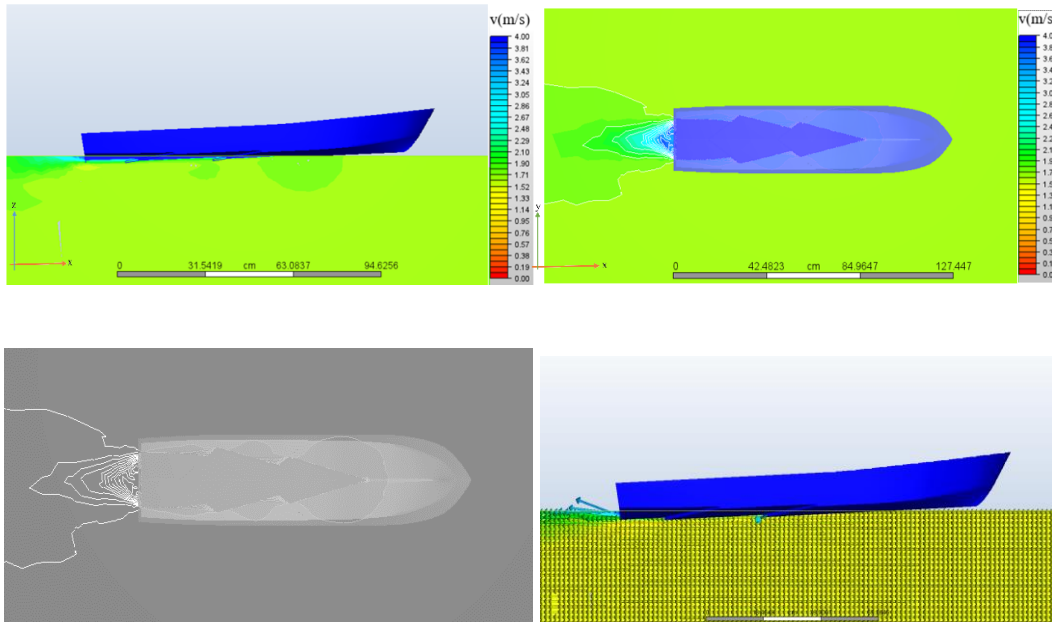

- Kecepatan 2.532 m/s dengan trim 3.026°

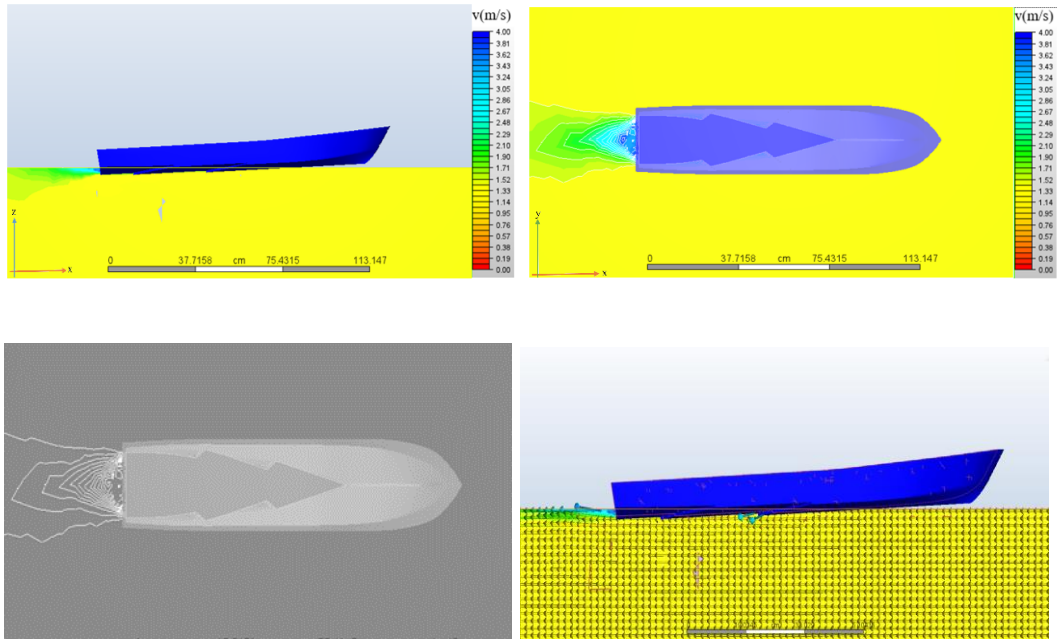

- Kecepatan 2.762 m/s dengan trim 3.364°

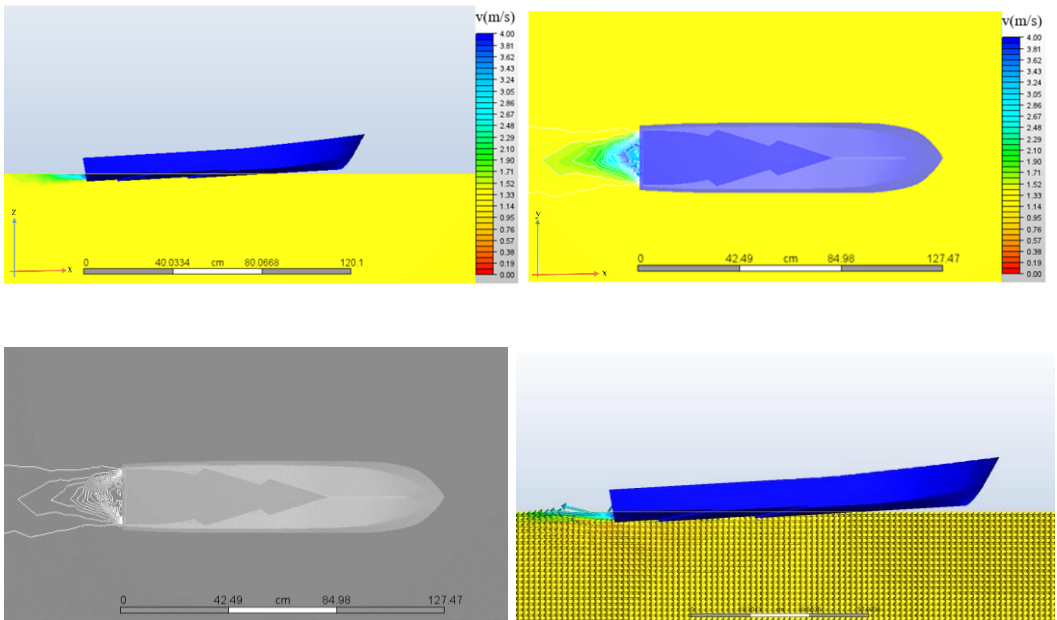

- Kecepatan 3.356 m/s dengan trim 3.996°

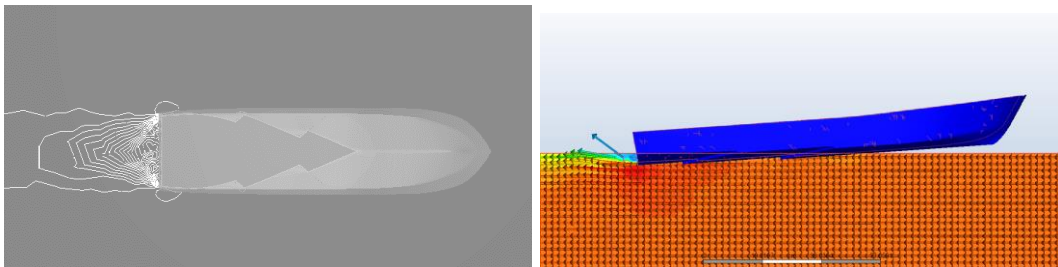
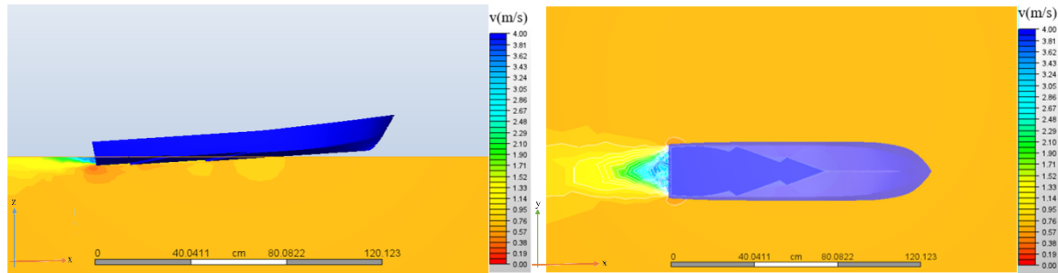

- Kecepatan 3.546 m/s dengan trim 4.283°

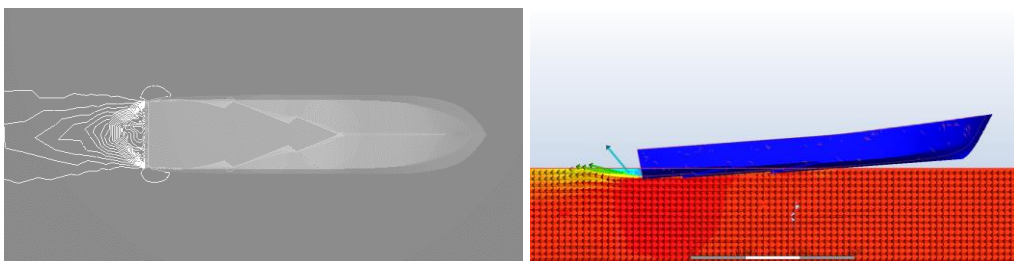
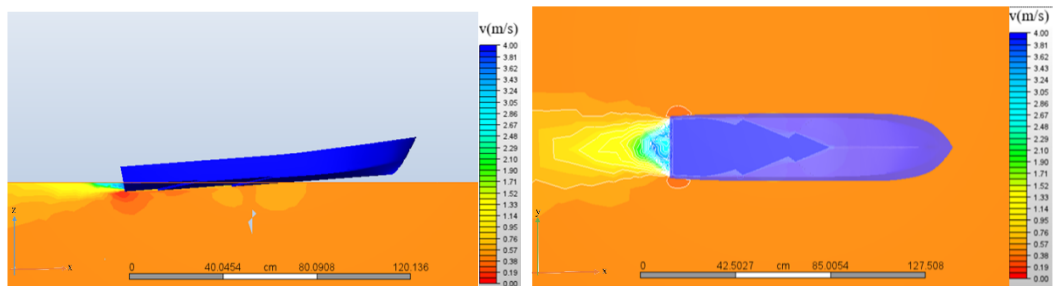

**Gambar visualisasi velocity magnitude pada model kapal tiga stepped V**

- Kecepatan 2.247 m/s dengan trim 2.277°

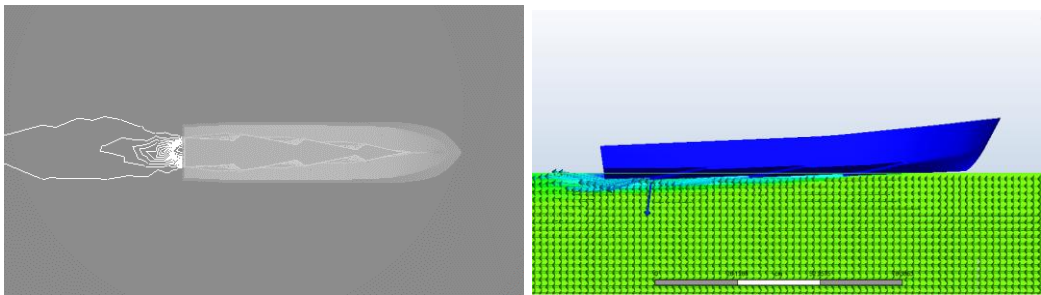
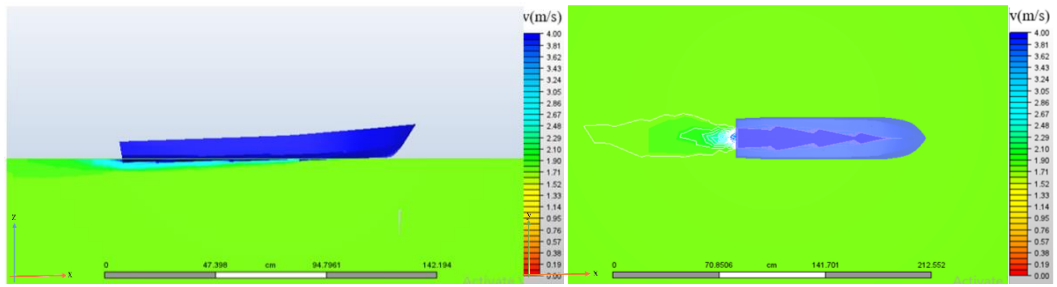

- Kecepatan 2.632 m/s dengan trim 2.471°

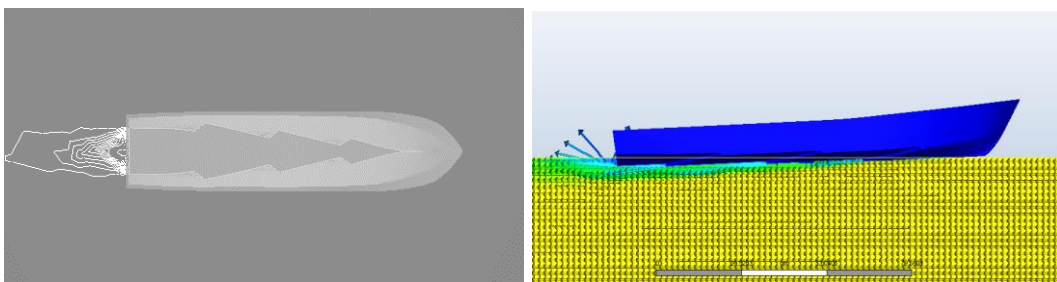
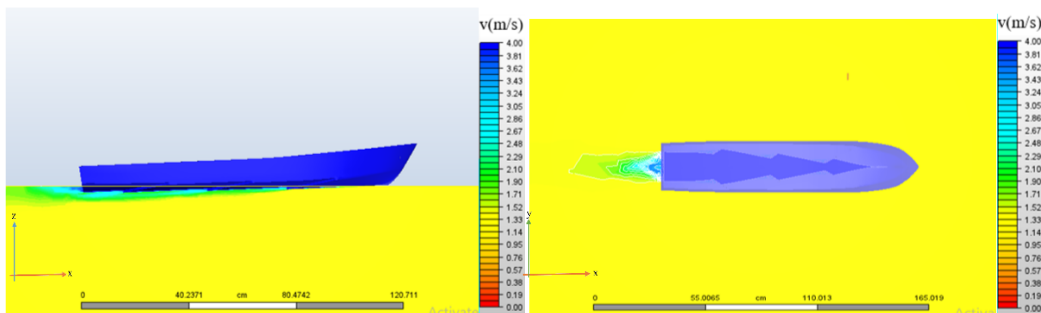



- Kecepatan 2.882 m/s dengan trim 2.693°

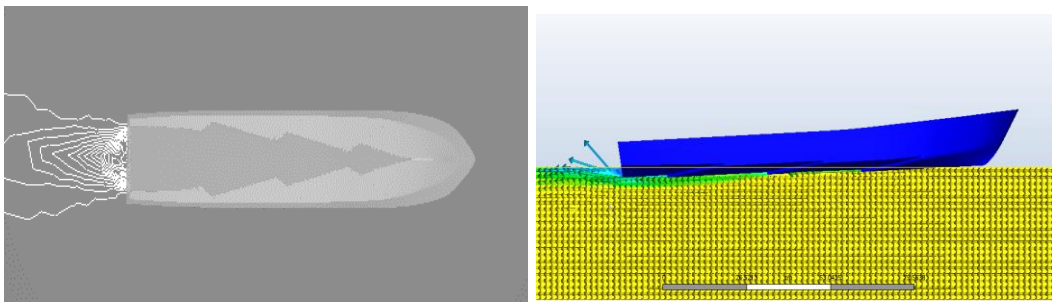
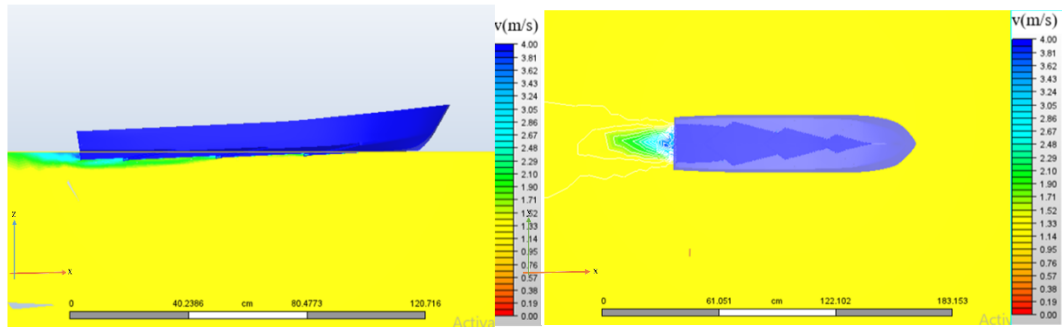

- Kecepatan 3.367 m/s dengan trim 3.2294°

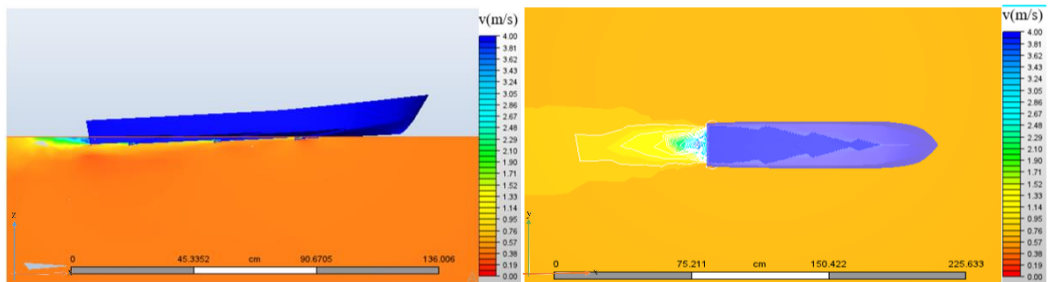

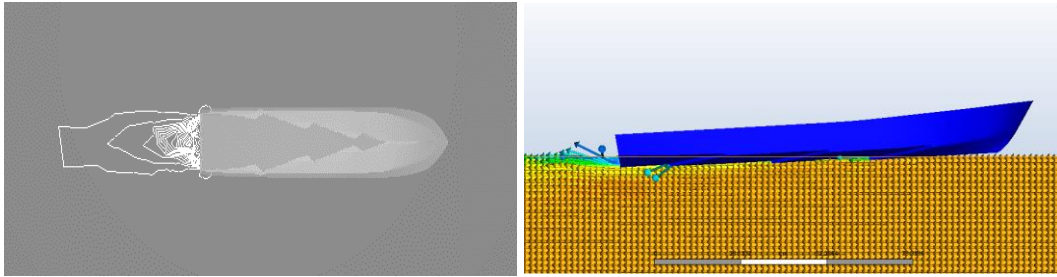

- Kecepatan 3.546 m/s dengan trim 3.714°

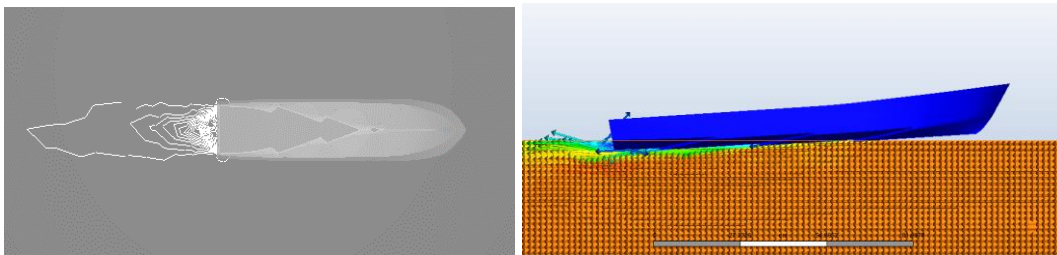
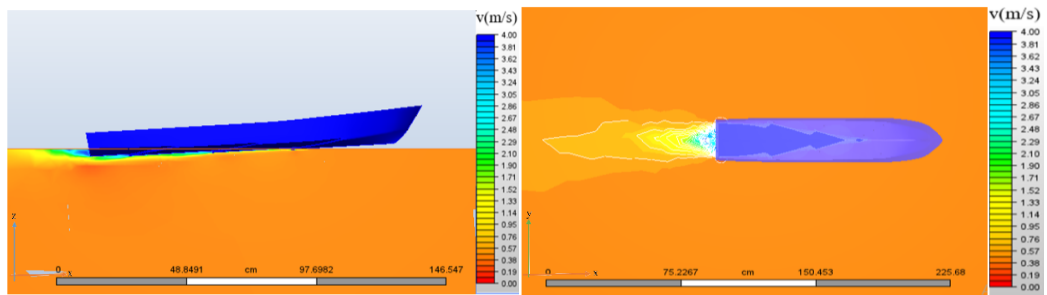

**Lampiran 4. Gambar visualisasi static pressure**

**Gambar visualisasi static pressure pada model kapal satu stepped V**

- Kecepatan 2.29 m/s dengan trim 2.88°

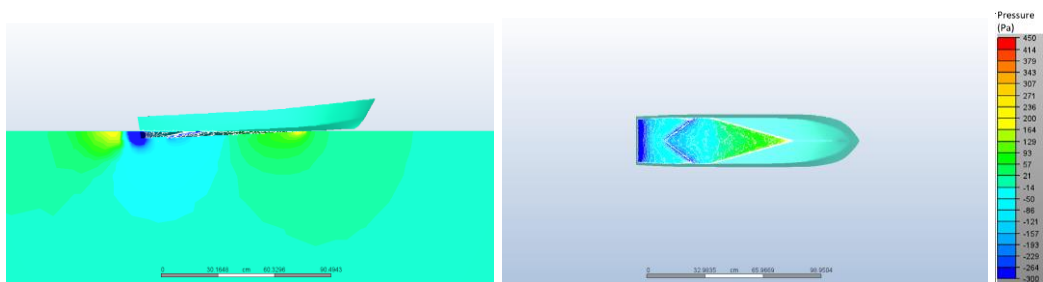

- Kecepatan 2.43 m/s dengan trim 3.18°

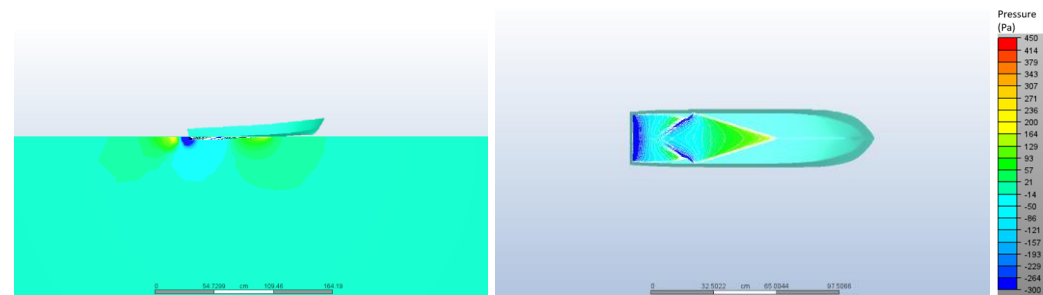

- Kecepatan 2.65 m/s dengan trim 3.55°

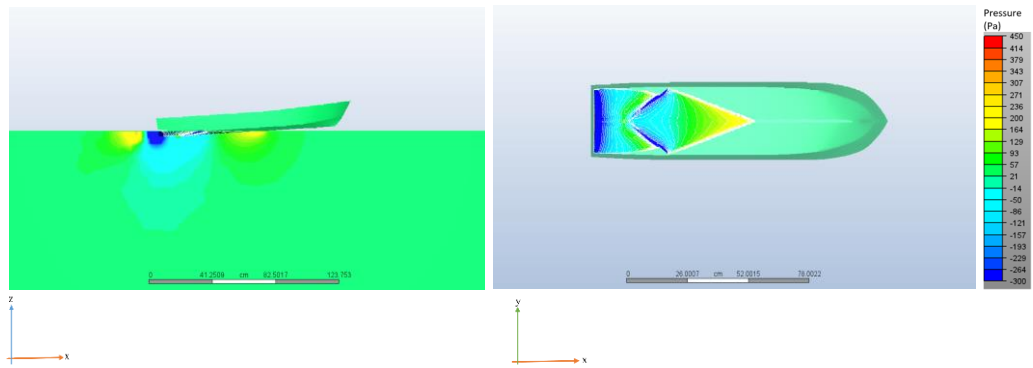

- Kecepatan 3.27 m/s dengan trim 4.13°

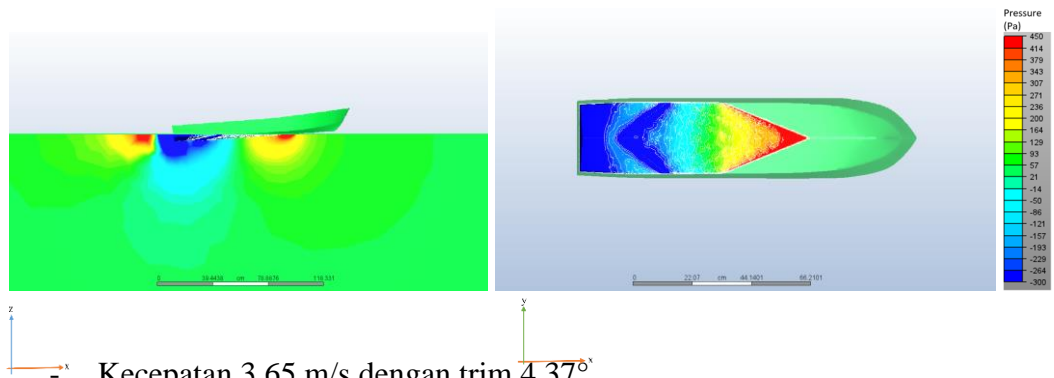

- Kecepatan 3.65 m/s dengan trim 4.37°

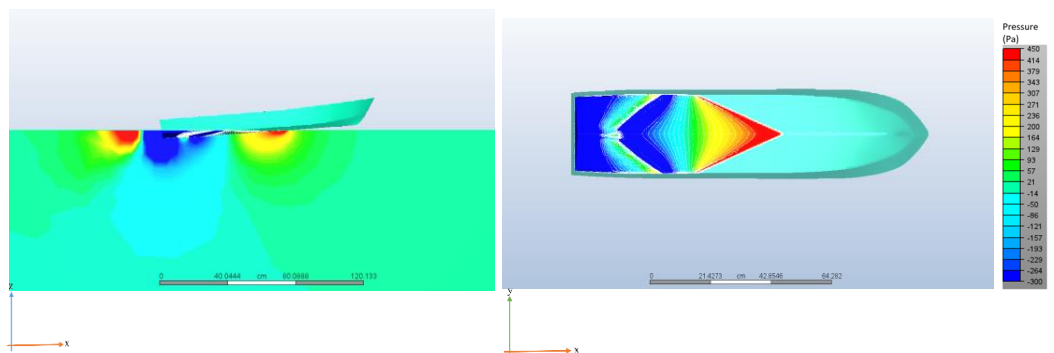

*Gambar visualisasi static pressure pada model kapal dua stepped V*

- Kecepatan 2.294 m/s dengan trim 2.61°

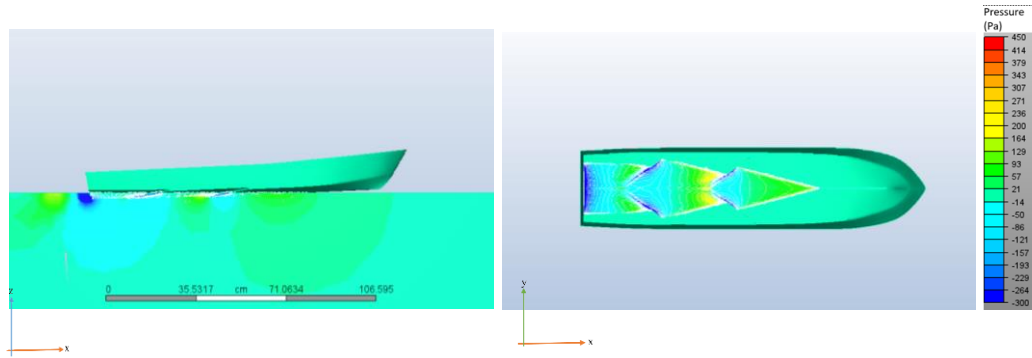

- Kecepatan 2.532 m/s dengan trim 3.026°

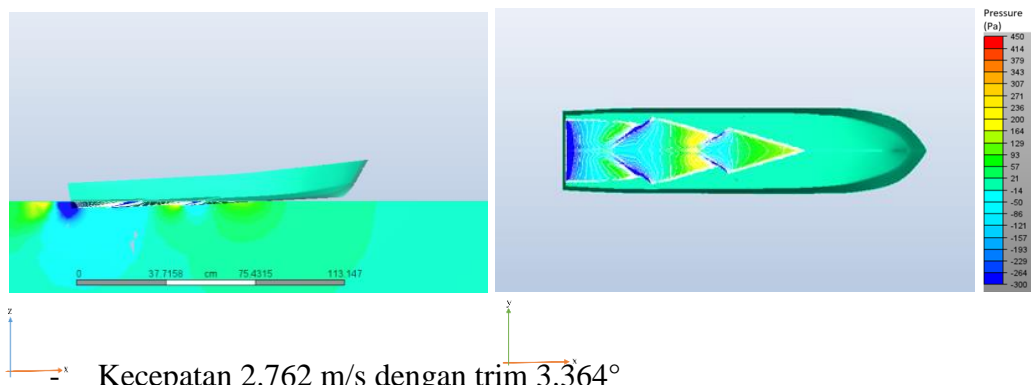

- Kecepatan 2.762 m/s dengan trim 3.364°

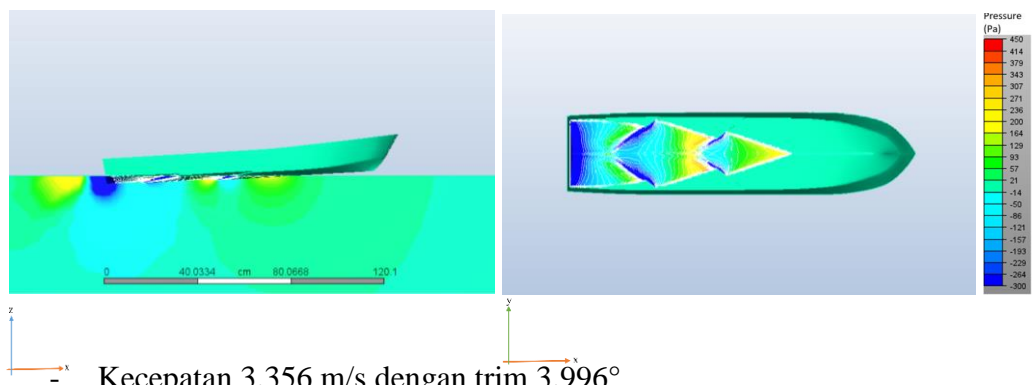

- Kecepatan 3.356 m/s dengan trim 3.996°

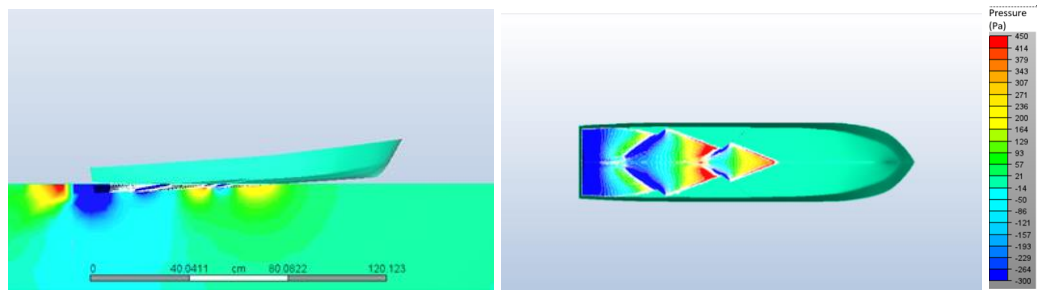

- Kecepatan 3.546 m/s dengan trim 4.283°

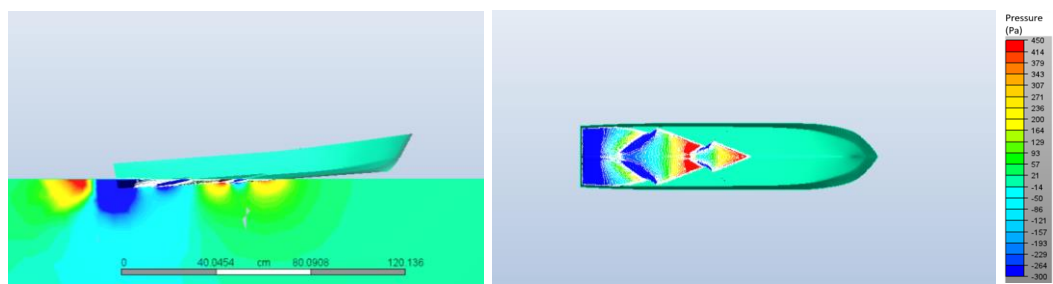

**Gambar visualisasi static pressure pada model kapal tiga stepped V**

- Kecepatan 2.247 m/s dengan trim 2.277°

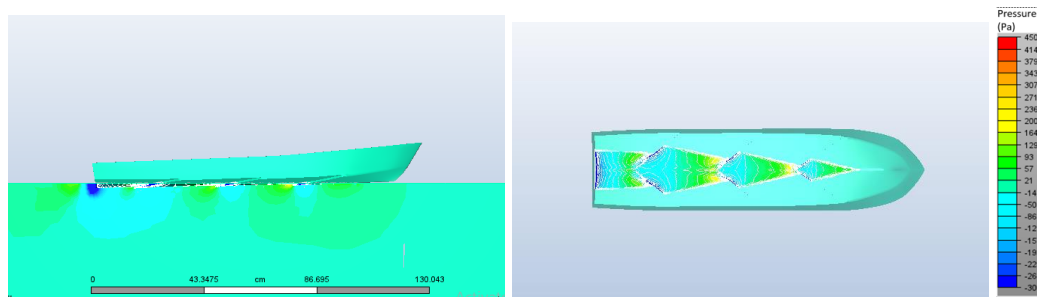

- Kecepatan 2.632 m/s dengan trim 2.471°

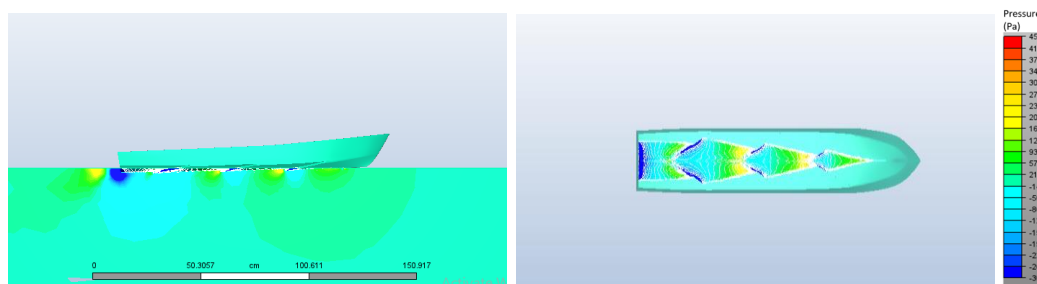

- Kecepatan 2.882 m/s dengan trim 2.693°

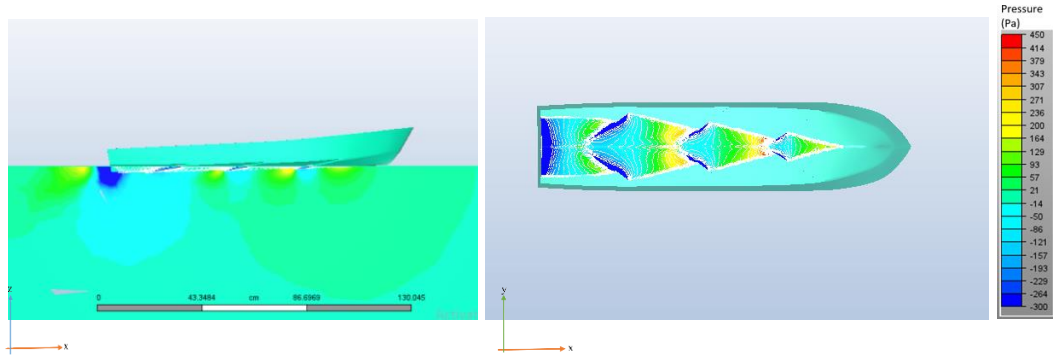

- Kecepatan 3.367 m/s dengan trim 3.2294°

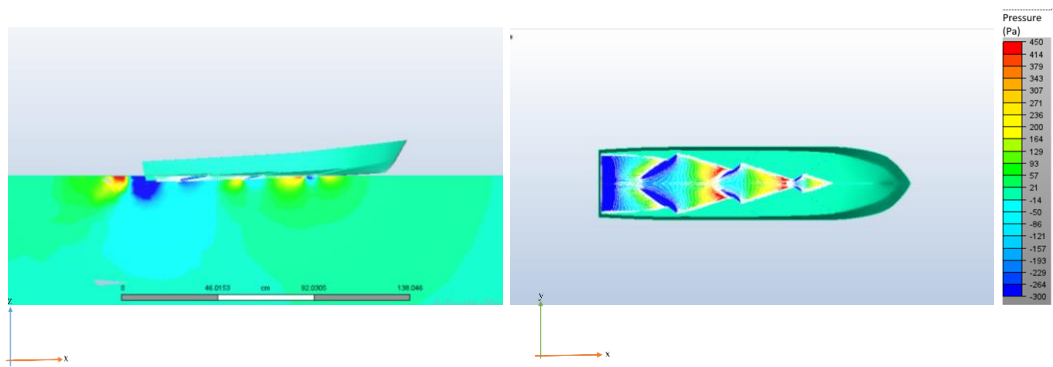

- Kecepatan 3.546 m/s dengan trim 3.714°

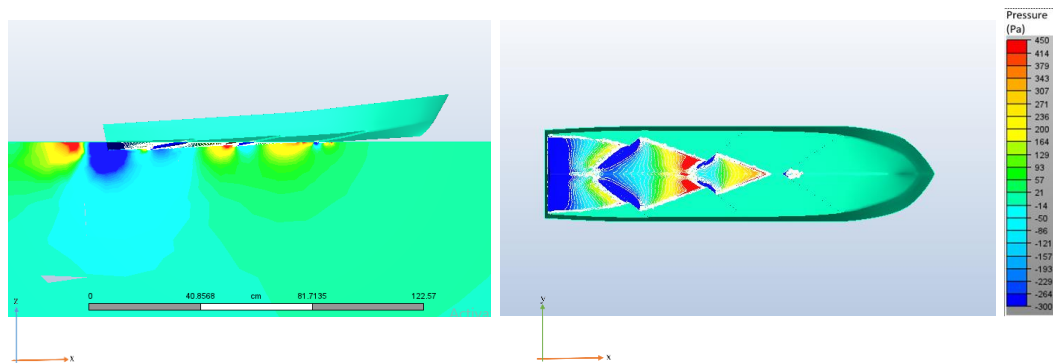

## Lampiran 5. Hasil perhitungan wall calculator tahanan model kapal

### Wall calculator tahanan model kapal satu stepped V

Wall calculator tahanan model kapal satu *stepped* V dengan kecepatan 2.123 m/s dengan trim 2.190°

---

Summary			
-----			
Total area	4216.04	cm <sup>2</sup>	
TOTAL FX	-2.77082	Newton	
TOTAL FY	-0.00693595	Newton	
TOTAL FZ	-9.10128	Newton	
Center of Force about X-Axis (Y-Z)	172.2	175.273	cm
Center of Force about Y-Axis (X-Z)	2241.15	176.336	cm
Center of Force about Z-Axis (X-Y)	2248.08	176.284	cm

---

Wall calculator tahanan model kapal satu *stepped* V dengan kecepatan 2.294 m/s dengan trim 2.885°

---

Summary			
-----			
Total area	3423.44	cm <sup>2</sup>	
TOTAL FX	-3.28543	Newton	
TOTAL FY	-0.0160457	Newton	
TOTAL FZ	-12.6586	Newton	
Center of Force about X-Axis (Y-Z)	176.806	175.162	cm
Center of Force about Y-Axis (X-Z)	2249.15	174.829	cm
Center of Force about Z-Axis (X-Y)	2250.96	176.849	cm

---

Wall calculator tahanan model kapal satu *stepped* V dengan kecepatan 2.439 m/s dengan trim 3.182°

---

Summary			
-----			
Total area	2710.3	cm <sup>2</sup>	
TOTAL FX	-3.82181	Newton	
TOTAL FY	-0.0307444	Newton	
TOTAL FZ	-8.96789	Newton	
Center of Force about X-Axis (Y-Z)	176.759	175.331	cm

---



Center of Force about Y-Axis (X-Z)	2262.26	174.276	cm
Center of Force about Z-Axis (X-Y)	2244.73	176.838	cm

Wall calculator tahanan model kapal satu *stepped* V dengan kecepatan 2.653 m/s dengan trim 3.551°

Summary			
-----			
Total area	2508.94	cm <sup>2</sup>	
TOTAL FX	-4.75662	Newton	
TOTAL FY	-0.0711143	Newton	
TOTAL FZ	-9.96408	Newton	
Center of Force about X-Axis (Y-Z)	176.708	175.278	cm
Center of Force about Y-Axis (X-Z)	2253.69	174.567	cm
Center of Force about Z-Axis (X-Y)	2243.9	176.722	cm

Wall calculator tahanan model kapal satu *stepped* V dengan kecepatan 2.959 m/s dengan trim 3.886°

Summary			
-----			
Total area	2370.17	cm <sup>2</sup>	
TOTAL FX	-7.04269	Newton	
TOTAL FY	-0.0287752	Newton	
TOTAL FZ	-12.1937	Newton	
Center of Force about X-Axis (Y-Z)	176.73	175.237	cm
Center of Force about Y-Axis (X-Z)	2236.18	174.72	cm
Center of Force about Z-Axis (X-Y)	2243.32	176.778	cm

Wall calculator tahanan model kapal satu *stepped* V dengan kecepatan 3.279 m/s dengan trim 4.127°

Summary			
-----			
Total area	3871.61	cm <sup>2</sup>	
TOTAL FX	-11.8446	Newton	
TOTAL FY	-0.00991608	Newton	
TOTAL FZ	-30.9281	Newton	

Center of Force about X-Axis (Y-Z)	176.841	174.574	cm
Center of Force about Y-Axis (X-Z)	2226.79	172.205	cm
Center of Force about Z-Axis (X-Y)	2242.42	176.876	cm

Wall calculator tahanan model kapal satu *stepped* V dengan kecepatan 3.650 m/s dengan trim 4.371°

Summary			
-----			
Total area	3206.75	cm <sup>2</sup>	
TOTAL FX	-16.602	Newton	
TOTAL FY	-0.0749534	Newton	
TOTAL FZ	-26.1828	Newton	
Center of Force about X-Axis (Y-Z)	176.846	174.766	cm
Center of Force about Y-Axis (X-Z)	2268.06	172.82	cm
Center of Force about Z-Axis (X-Y)	2239.74	176.884	cm

Wall calculator tahanan model kapal satu *stepped* V dengan kecepatan 4.167 m/s dengan trim 4.634°

Summary			
-----			
Total area	3144.7	cm <sup>2</sup>	
TOTAL FX	-17.0551	Newton	
TOTAL FY	-0.0727277	Newton	
TOTAL FZ	-41.6227	Newton	
Center of Force about X-Axis (Y-Z)	176.802	174.773	cm
Center of Force about Y-Axis (X-Z)	2247.57	173.114	cm
Center of Force about Z-Axis (X-Y)	2242.22	176.847	cm

### Wall calculator tahanan model kapal dua *stepped* V

Wall calculator tahanan model kapal dua *stepped* V dengan kecepatan 2.169 m/s dengan trim 2.241°

Summary			
-----			
Total area	2324.49	cm <sup>2</sup>	
TOTAL FX	-1.60282	Newton	

TOTAL FY	-0.0226239	Newton	
TOTAL FZ	-3.00123	Newton	
Center of Force about X-Axis (Y-Z)	-16.0065	-0.590642	cm
Center of Force about Y-Axis (X-Z)	-977.727	-0.93898	cm
Center of Force about Z-Axis (X-Y)	-999.272	-15.934	cm

Wall calculator tahanan model kapal dua *stepped V* dengan kecepatan 2.294 m/s dengan trim 2.610°

Summary			
-----			
Total area	2367.02	cm <sup>2</sup>	
TOTAL FX	-2.18738	Newton	
TOTAL FY	-0.085641	Newton	
TOTAL FZ	-3.81874	Newton	
Center of Force about X-Axis (Y-Z)	-15.9925	174.044	cm
Center of Force about Y-Axis (X-Z)	-988.409	-1.03894	cm
Center of Force about Z-Axis (X-Y)	-1002.11	-15.967	cm

Wall calculator tahanan model kapal dua *stepped V* dengan kecepatan 2.532 m/s dengan trim 3.026°

Summary			
-----			
Total area	2558.57	cm <sup>2</sup>	
TOTAL FX	-3.70217	Newton	
TOTAL FY	-0.0102451	Newton	
TOTAL FZ	-6.17114	Newton	
Center of Force about X-Axis (Y-Z)	-15.9855	-0.807799	cm
Center of Force about Y-Axis (X-Z)	-1036.25	-0.55955	cm
Center of Force about Z-Axis (X-Y)	-1003.49	-15.9637	cm

Wall calculator tahanan model kapal dua *stepped V* dengan kecepatan 2.762 m/s dengan trim 3.364°

Summary			
-----			
Total area	2710.93	cm <sup>2</sup>	
TOTAL FX	-5.53745	Newton	
TOTAL FY	-0.0392545	Newton	

TOTAL FZ	-9.00905	Newton	
Center of Force about X-Axis (Y-Z)	-16.0175	-0.923512	cm
Center of Force about Y-Axis (X-Z)	-974.621	-1.50264	cm
Center of Force about Z-Axis (X-Y)	-1003.81	-15.9105	cm

---

Wall calculator tahanan model kapal dua *stepped V* dengan kecepatan 2.959 m/s dengan trim 3.659°

Summary			
-----			
Total area	2730.97	cm <sup>2</sup>	
TOTAL FX	-6.83031	Newton	
TOTAL FY	-0.0378142	Newton	
TOTAL FZ	-10.9171	Newton	
Center of Force about X-Axis (Y-Z)	-15.9486	-0.972394	cm
Center of Force about Y-Axis (X-Z)	-986.139	-2.5098	cm
Center of Force about Z-Axis (X-Y)	-1005.52	-15.9245	cm

---

Wall calculator tahanan model kapal dua *stepped V* dengan kecepatan 3.356 m/s dengan trim 3.996°

Summary			
-----			
Total area	2714.38	cm <sup>2</sup>	
TOTAL FX	-10.1468	Newton	
TOTAL FY	-0.0973559	Newton	
TOTAL FZ	-14.4374	Newton	
Center of Force about X-Axis (Y-Z)	-16.0251	-1.06947	cm
Center of Force about Y-Axis (X-Z)	-978.727	-1.59255	cm
Center of Force about Z-Axis (X-Y)	-1007.23	-15.9991	cm

---

Wall calculator tahanan model kapal dua *stepped V* dengan kecepatan 3.546 m/s dengan trim 4.283°

Summary			
-----			
Total area	2598.63	cm <sup>2</sup>	
TOTAL FX	-12.0195	Newton	
TOTAL FY	-0.0850525	Newton	

TOTAL FZ	-16.2783	Newton	
Center of Force about X-Axis (Y-Z)	-15.9635	-1.11097	cm
Center of Force about Y-Axis (X-Z)	-983.026	-1.64565	cm
Center of Force about Z-Axis (X-Y)	-1008.3	-15.9355	cm

Wall calculator tahanan model kapal dua *stepped V* dengan kecepatan 3.65 m/s dengan trim 4.466°

Summary			
-----			
Total area	2565.29	cm <sup>2</sup>	
TOTAL FX	-12.1486	Newton	
TOTAL FY	-0.127617	Newton	
TOTAL FZ	-17.4076	Newton	
Center of Force about X-Axis (Y-Z)	-15.9758	-1.09908	cm
Center of Force about Y-Axis (X-Z)	-960.473	-1.18065	cm
Center of Force about Z-Axis (X-Y)	-1009.75	-15.9248	cm

### Wall calculator tahanan model kapal tiga *stepped V*

Statistik *mesh* model kapal tiga *stepped V* dengan kecepatan 2.132 m/s dengan trim 2.194°

Summary			
-----			
Total area	1865.69	cm <sup>2</sup>	
TOTAL FX	-1.17587	Newton	
TOTAL FY	-0.03502	Newton	
TOTAL FZ	-1.62997	Newton	
Center of Force about X-Axis (Y-Z)	-14.2548	-0.43073	cm
Center of Force about Y-Axis (X-Z)	-953.849	-0.79056	cm
Center of Force about Z-Axis (X-Y)	-1004.27	-14.4474	cm

Statistik *mesh* model kapal tiga *stepped V* dengan kecepatan 2.247 m/s dengan trim 2.277°

Summary			
-----			

Total area	1998.57	cm <sup>2</sup>	
TOTAL FX	-1.65583	Newton	
TOTAL FY	-0.04917	Newton	
TOTAL FZ	-2.27762	Newton	
Center of Force about X-Axis (Y-Z)	-12.9698	-0.49523	cm
Center of Force about Y-Axis (X-Z)	-950.237	-0.82179	cm
Center of Force about Z-Axis (X-Y)	-1001.63	-12.9264	cm

Statistik *mesh* model kapal tiga *stepped V* dengan kecepatan 2.632 m/s dengan trim 2.471°

Summary			
-----			
Total area	2624.26	cm <sup>2</sup>	
TOTAL FX	-3.21126	Newton	
TOTAL FY	-0.043518	Newton	
TOTAL FZ	-4.8151	Newton	
Center of Force about X-Axis (Y-Z)	-11.9294	-0.648744	cm
Center of Force about Y-Axis (X-Z)	-958.29	-1.10004	cm
Center of Force about Z-Axis (X-Y)	-1003.3	-11.898	cm

Statistik *mesh* model kapal tiga *stepped V* dengan kecepatan 2.882 m/s dengan trim 2.693°

Summary			
-----			
Total area	2823.68	cm <sup>2</sup>	
TOTAL FX	-4.40775	Newton	
TOTAL FY	-0.024384	Newton	
TOTAL FZ	-6.81999	Newton	
Center of Force about X-Axis (Y-Z)	-13.5632	-0.725289	cm
Center of Force about Y-Axis (X-Z)	-918.34	-0.618318	cm
Center of Force about Z-Axis (X-Y)	-1007.22	-13.5284	cm

Statistik *mesh* model kapal tiga *stepped V* dengan kecepatan 3.003 m/s dengan trim 2.849°

Summary			
-----			

Total area	2813.58	cm <sup>2</sup>	
TOTAL FX	-5.57	Newton	
TOTAL FY	-0.099079	Newton	
TOTAL FZ	-8.28219	Newton	
Center of Force about X-Axis (Y-Z)	-12.0085	-0.787966	cm
Center of Force about Y-Axis (X-Z)	-969.491	-1.02216	cm
Center of Force about Z-Axis (X-Y)	-1006.55	-11.9426	cm

Statistik *mesh* model kapal tiga *stepped* V dengan kecepatan 3.367 m/s dengan trim 3.229°

Summary			
-----			
Total area	2822.77	cm <sup>2</sup>	
TOTAL FX	-8.38292	Newton	
TOTAL FY	-0.071599	Newton	
TOTAL FZ	-12.1359	Newton	
Center of Force about X-Axis (Y-Z)	-14.1662	-0.887742	cm
Center of Force about Y-Axis (X-Z)	-958.321	-1.02272	cm
Center of Force about Z-Axis (X-Y)	-1007.75	-14.1415	cm

Statistik *mesh* model kapal tiga *stepped* V dengan kecepatan 3.546 m/s dengan trim 3.714°

Summary			
-----			
Total area	2307.24	cm <sup>2</sup>	
TOTAL FX	-9.1968	Newton	
TOTAL FY	-0.079715	Newton	
TOTAL FZ	-12.9817	Newton	
Center of Force about X-Axis (Y-Z)	-12.4392	-0.921577	cm
Center of Force about Y-Axis (X-Z)	-962.23	-0.77272	cm
Center of Force about Z-Axis (X-Y)	-1006.67	-12.3733	cm

Statistik *mesh* model kapal tiga *stepped* V dengan kecepatan 3.623 m/s dengan trim 4.042°

Summary			
-----			

Total area	2344.44	cm <sup>2</sup>	
TOTAL FX	-9.30218	Newton	
TOTAL FY	-0.05251	Newton	
TOTAL FZ	-16.6592	Newton	
Center of Force about X-Axis (Y-Z)	-12.4024	-0.93150	cm
Center of Force about Y-Axis (X-Z)	-974.668	-1.46582	cm
Center of Force about Z-Axis (X-Y)	-1006.88	-12.4018	cm

### Lampiran 6. Penentuan Skala Model

Penentuan Skala dilakukan untuk menghindari terjadinya ombak pada dinding tangki atau yang di sebut *blockage effect* dimana ukuran model harus disesuaikan dengan ukuran tangki serta tinggi air dalam tangki dengan sarat model. Menurut harvald, penentuan lebar model ( $B_m$ ) adalah sebagai berikut :

$$B_m < 1/10 B \text{ Tangki}$$

Diketahui

$$\begin{aligned} B \text{ tangki} &= 3.54 \text{ m} \\ &= (1/10) \times 3.54 \\ &= 0.354 \text{ m} \end{aligned}$$

Maka lebar model yang digunakan supaya tidak menimbulkan *blockage effect* dan dapat digunakan untuk pengujian model di towing tank yaitu:

$$B_m < 0.354$$

Berdasarkan perhitungan dari persamaan diatas , maka penentuan skala model kapal dapat ditentukan melalui table berikut:



Bs (m)	Skala	Bm(m)
4.5	1:10	0.45
4.5	1:15	0.30
4.5	1:20	0.23
4.5	1:25	0.18

Dari table diatas ukuran lebar model kapal maksimal yang memenuhi Kriteria yaitu 0,30 m sehingga skala yang dignakan untuk ukuran model kapal yaitu 1 :

